

MORE LIFE IN THE GARDEN



GARDEN CABINS • GARAGES • PAVILIONS • CHILDREN'S PLAYHOUSES

CONTENT



LASITA MAJA	2	Caroline	72
Your garden cabin	2	Caroline 2.1	74
About Lasita Maja	4	Caroline 2.2	74
Our colours	6	Caroline 2.3	76
		Wrexham	78
TOP LINE	8	Balmoral	79
Top Line in detail	10	Alex	80
Austin 1 NEW!	12	Jubilee	82
Austin 2 NEW!	12	Elgin	83
Austin 3 NEW!	14	Baruda	84
Austin 4 NEW!	15	Sri Lanka	85
Austin 5 NEW!	16	Windsor	86
Austin 6 NEW!	17	Kensington	87
Austin 7 NEW!	18	Pembrokeshire	88
Murano 1	20	Portsmouth	89
Murano 2	21	Lyndhurst	90
Murano 3	22	Liverpool	91
Sardinia 1	24		
Sardinia 2	24	CHILDREN'S PLAYHOUSES	92
Sardinia 3	26	Lido	94
		Pinocchio	95
DOMEO RANGE	28	Flipp	96
Domeo in detail	30	Pingo	97
Domeo 1	32	Tivoli	98
Domeo 2	33	Pippi	99
Domeo 3 + covered area	34		
Domeo 3 Loggia	35	GARAGES	100
Domeo 4 + covered area	36	Garages in detail	102
Domeo 4 Loggia	37	Bahamas	104
Domeo 5 + covered area	38	Sectional garage door	105
Domeo 6	40	Bahamas 2 NEW!	106
Domeo 6 Loggia	40	Canberra	108
Domeo 7	42	Hawaii	110
Domeo 8	43	Falkland	111
Domeo 9	44		
Domeo 10	45	PAVILIONS	112
Domeo 11	46	Pavilions in detail	114
		Ilmenau	116
GARDEN CABINS	48	Inverness	117
Garden cabins in detail	50	Rivera	118
Sicily 1	56	Jamaica	119
Sicily 2	57		
Oban	58	HOLIDAY HOMES	120
Edinburgh	59		
Dorset 1	60	ACCESSORIES	126
Dorset 2	60	Doors	128
Dorset 3	60	Windows	130
Dorset 71	60	Accessories	132
Dorset 72	60		
Dorset 73	60	GOOD TO KNOW	136
Sussex	62	CARE INSTRUCTIONS	138
Anders	64	QUALITY FEATURES	139
Java	66		
Little Rock	67		
Brighton	68		
Japan	70		
Chameleon	71		

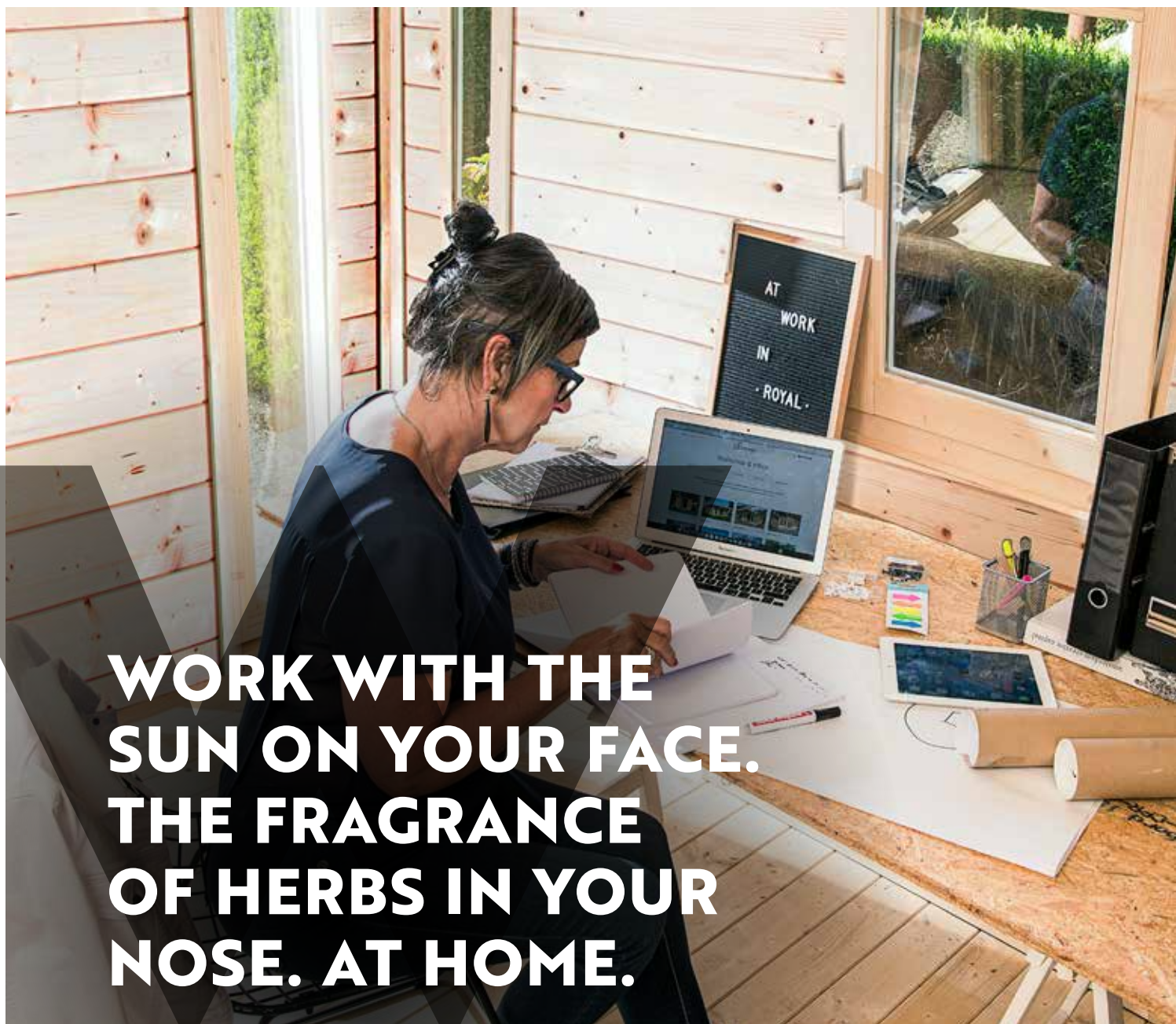

**WORK WITH THE
SUN ON YOUR FACE.
THE FRAGRANCE
OF HERBS IN YOUR
NOSE. AT HOME.**

Working in your own garden

A pleasant workstation in your garden cabin - why not? Lasita Maja's garden cabins are perfect for this: high quality, modern and cosy at the same time. A range of accessories make sure that there is something suitable for everyone. The best thing is that your own home is not far away, yet there is enough distance between the two - both spatially and emotionally. So it's not hard to wind down in the evening. Just step outside the door, take a deep breath and enjoy the atmosphere of your garden.





SUSSEX 2

p. 59,
Natural



AUSTIN 6

p. 17,
Green-grey

The options are many. With our large selection of garden cabins, you are sure to find your favourite place.



**FROM OFFICE
TO SUNLOUNGER
IN 10 STEPS OR
10 SECONDS.**



Lasita Maja.

MORE THAN 20 YEARS OF QUALITY

EVERY GARDEN CABIN BEGINS WITH A DREAM.

It's your dream. At Lasita Maja, we bring it to life.

As an experienced manufacturer of high-quality log cabins, we produce children's playhouses, pavilions, garages and individual holiday homes, as well as classic garden cabins. To do this, we use the best wood and combine modern and gentle processing technology with traditional craftsmanship and secure packaging. We are well aware that high quality equals happy customers. And if there's one thing that matters most, it's getting the details right.



CERTIFIED WOOD

We use only select Nordic spruce for our garden cabins. Its flexible properties make it perfect for use as building and construction timber. Its slow growth in Europe's colder regions makes the wood particularly sturdy and solid.

In general, wood is a sustainable, renewable raw material. Since we value environmentally responsible timber management, all our products in this catalogue are FSC® Mix or PEFC certified.



SNAP & LIKE

FOLLOW US ON FACEBOOK.



Ask about FSC® certified products.





OUR RECIPE FOR SUCCESS: HIGH-QUALITY NORDIC RAW MATERIALS, STATE-OF-THE-ART PROCESSING AND DECADES OF EXPERIENCE.

To ensure that we deliver a unique product, we rely on long-standing employees with a great deal of experience and modern machinery. Trained eyes inspect and sort the materials and components. Our precision machine tools saw, plane and mill the individual parts to the correct dimensions and shapes. Before being carefully and securely packed, everything undergoes a final inspection.

In order to be able to offer our customers the best quality, we have implemented a quality management system that complies with the requirements of the ISO 9001 standard. Our products also come with a 2-year or a 5-year warranty (on all wooden parts).



DELIVERED TO YOUR DOOR

The assembly kit

Your garden cabin will be delivered as a complete kit in one or more packs. Comprehensive assembly instructions are included. If you do not begin assembly immediately after delivery, store your garden cabin in a dry location, protected from UV light.

Delivery

We deliver our products to your specialist dealer on request or “to the kerb” at your home for an additional charge. Delivery will be made on the agreed date using a 40 t HGV. There must be no restrictions to access for this vehicle.

Presenting:

THE HIGH-END PAINT SYSTEM FOR GARDEN CABINS MADE IN ESTONIA.



The environmentally friendly water-based stain is ideal for professional use outdoors and provides lasting protection for your garden cabin.

ALL CABINS IN 4 COLOURS. NO UNDERCOAT REQUIRED!



Light Grey



Carbon Grey



New - Green-grey



Swedish Red

Our 4 colours

Wooden doors, windows and cover strips are always supplied in a timeless cream white, which in combination with the main colours results in four attractive variants. In addition, we offer a water-based glaze - a reliable and long-lasting protection that is ideal for professional outdoor use. Please note that the colours shown may differ slightly from the actual finish, as printing inks affect colour reproduction and therefore slight differences may occur.

At a glance

- Garden cabin delivered as standard with a natural finish
- Environmentally friendly and low-odour treatment
- Ideal protection against weather, fungi, insect infestation, mildew and blue stain
- Paint for repairing minor damage included in delivery
- Recommended maintenance interval 5 years (depending on location, compass direction and colour), Lasita Maja warranty max. 5 years*.
- Slight colour differences are possible due to the nature of the wood.

The advantages of our wood treatment

- No undercoat required.
- 3-sided colour treatment of the wall boards
- Natural finish on the interior, creating a natural feeling of wellbeing inside
- Unique six-sided colour treatment of the log corner joints and log heads
- Natural roof purlins and roof boards

*Find out more about our warranty conditions in the installation instructions or at www.lasita.com.

REVERSE INSTALLATION

Please note that reverse installation of coloured garden cabins is not possible due to the one-sided colour finish!

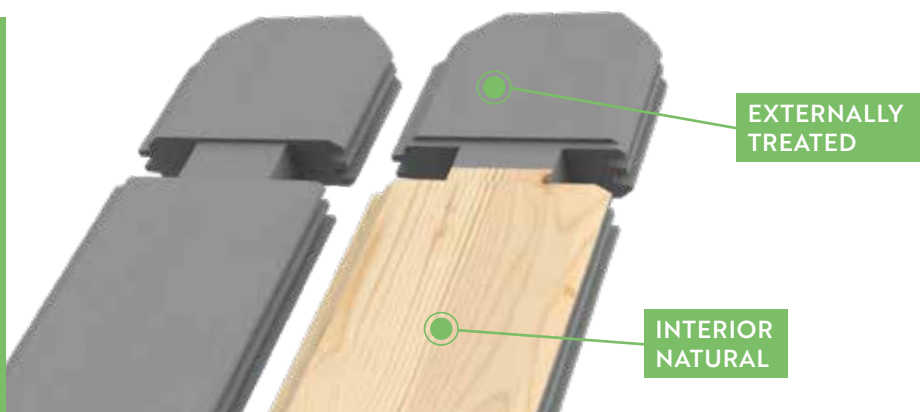



TOP LINE.

TRENDY GARDEN CABINS WITH ALUMINIUM WINDOWS AND DOORS. FOR MAXIMUM STURDINESS AND A PERFECT VIEW.

13

MODELS

04

COLOURS

02

WALL THICKNESSES



CONSTRUCTION	
1 Wall thickness mm	44
2 Double tongue and groove Wind-tight chalet connection	44 mm +
3 Wind protection	-
4 Wall insulation	Depends on the model, optional
5 Impregnated substructure	+
6 Floorboards	18.5 mm
ROOF CONSTRUCTION	
7 Roof boards	18.5 mm
8 Roof construction	Roof purlins



Key facts

**SPRUCE
44 MM**

**WALL BOARDS WITH
DOUBLE TONGUE AND GROOVE
IMPREGNATED SUBSTRUCTURE**

**FLOORBOARDS 18.5 MM
ROOF BOARDS 18.5 MM**

SAFETY GLASS

**U-VALUE WINDOW /
DOOR 3.0 / 2.6**

05

**-YEAR
WARRANTY**
ON THE CONSTRUCTION

TOP LINE. STURDY ALL-ROUNDERS WITH A HIGH STANDARD OF DESIGN.

ALU +

Modern, functional and heat-insulating: Windows and doors in aluminium. They create an attractive element of style in the classic log cabin, provide maximum protection from the weather and exude a natural living atmosphere. The high-tech aluminium materials and the traditional wood materials are an unbeatable pair.

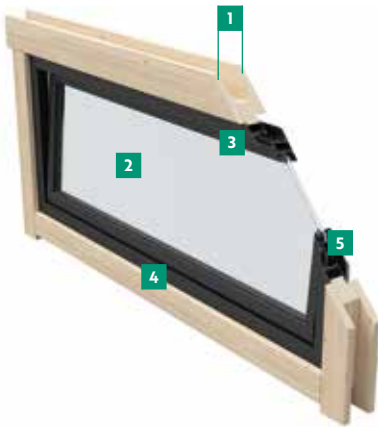

WINDOW

Wood type glued wood	Untreated spruce
1 Profile thickness mm	44
2 Safety glass	Double (4 / 6 / 4)
U-value > W / m ² K	3.0
3 Rubber seal	+
4 Drip cap	Aluminium
Window opening	Interior
5 Opening system	1-hand tilt&turn



SAFETY GLASS

DOORS

Wood type glued wood	Untreated spruce
1 Profile thickness mm	44
2 Safety glass	Double (4 / 20 / 4)
U-value > W / m ² K	2.6
3 Rubber seal	+
4 Door threshold	Aluminium
Door opening	Exterior
5 Lock	Cylinder



SAFETY GLASS

NEW!

Premium wood clad windows with robust aluminium frames

Pressure impregnated substructure

8.12 m² Austin 2

AUSTIN ALU+

**SMALL IN SIZE, BIG IN FUNCTION -
PERFECT FOR RELAXING MOMENTS
EVEN IN A SMALL GARDEN.**



	AUSTIN 1	AUSTIN 2
Item number	4431419	4431519
Base dimensions W × D	300 × 240 cm	360 × 240 cm
Wall thickness	44 mm	44 mm
Floor area	6.73 m ²	8.12 m ²
Capacity	16.12 m ³	19.44 m ³
Side wall height	239 cm	239 cm
Ridge height	239 cm	239 cm
Roof overhang	10 cm	10 cm
Roof area	8,2 m ²	9,85 m ²
Glazed sliding door W × H	204.1 × 202.6 cm	204.1 × 202.6 cm
Single window W × H	100.3 × 202.6 cm	100.3 × 202.6 cm
Floor thickness	18.5 mm	18.5 mm
Onduline, optional	X	X

APPROPRIATE ACCESSORIES

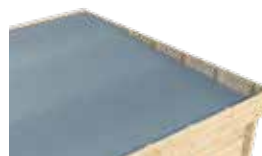

Onduline



Gutter

Other accessories can be found from page 126



6.73 m²

Austin 1

NEW!

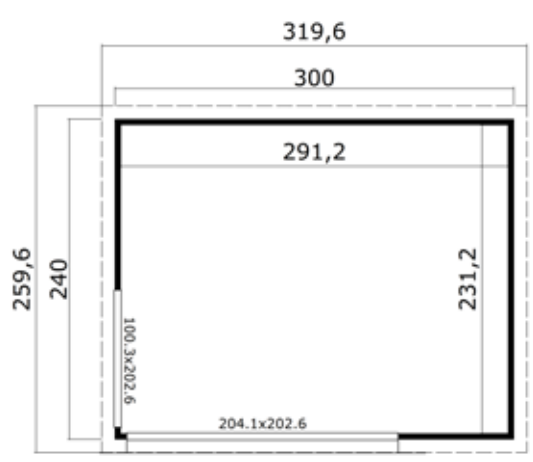

AUSTIN 1

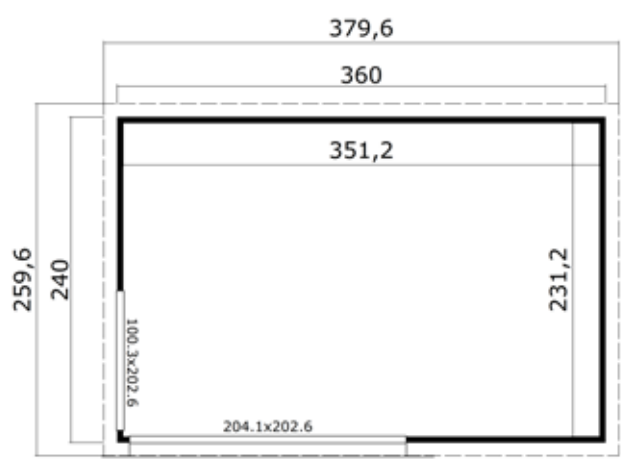

AUSTIN 2



AUSTIN 3 ALU+

CONTEMPORARY GARDEN SHED WITH LARGE GLASS FRONT.



	AUSTIN 3
Item number	4431619
Base dimensions W x D	360 x 240 cm
Wall thickness	44 mm
Floor area	8.12 m ²
Capacity	19.44 m ³
Side wall height	239 cm
Ridge height	239 cm
Roof overhang	10 cm
Roof area	9.85 m ²
Glazed sliding door W x H	303.9 x 202.6 cm
Floor thickness	18.5 mm
Onduline, optional	2 x

APPROPRIATE ACCESSORIES

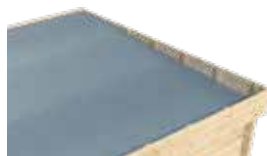

Onduline



Gutter

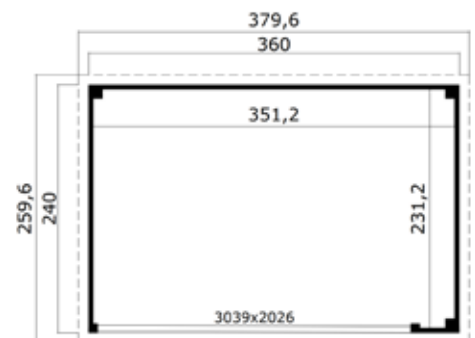

Other accessories can be found from page 126

NEW!

Natural spruce wood

9.51 m²

AUSTIN 4 ALU+

PERFECT FOR MOMENTS OF RELAXATION - VERSATILE IN USE.



	AUSTIN 4
Item number	4431719
Base dimensions W x D	420 x 240 cm
Wall thickness	44 mm
Floor area	9.51 m ²
Capacity	22.76 m ³
Side wall height	239 cm
Ridge height	239 cm
Roof overhang	10 cm
Roof area	11.22 m ²
Glazed sliding door W x H	303.9 x 202.6 cm
Floor thickness	18.5 mm
Onduline, optional	2 x

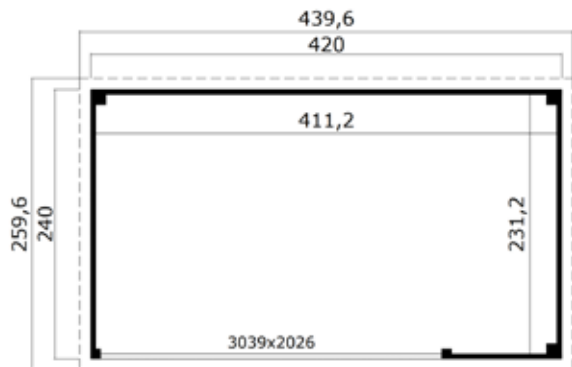

NEW!

Additional large window

Pressure impregnated substructure

8.12 m²

AUSTIN 5 ^{ALU +}

LARGE WINDOW FRONT AND SIDE WINDOWS FOR PLENTY OF DAYLIGHT.

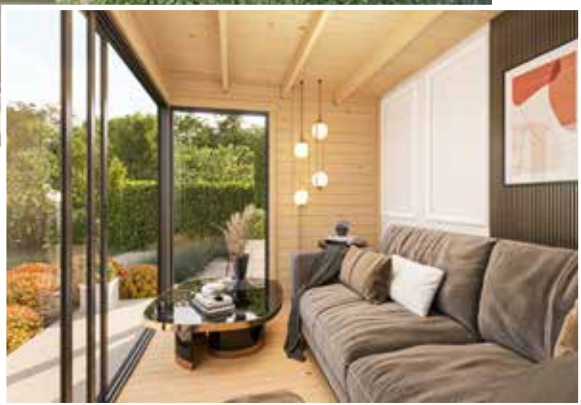

AUSTIN 5	
Item number	4431819
Base dimensions W x D	360 x 240 cm
Wall thickness	44 mm
Floor area	8.12 m ²
Capacity	19.44 m ³
Side wall height	239 cm
Ridge height	239 cm
Roof overhang	10 m ²
Roof area	9.85 m ²
Glazed sliding door W x H	303.9 x 202.6 cm
Single window W x H	100.3 x 202.6 cm
Floor thickness	18.5 mm
Onduline, optional	2 x

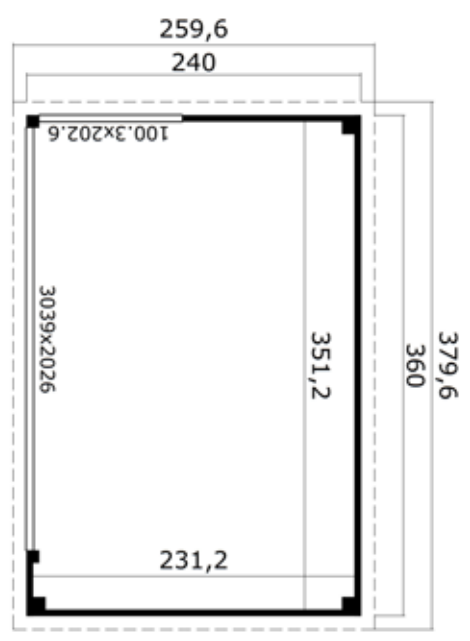

NEW!

Premium windows with insulating glazing



10.23 m²



AUSTIN 6 ^{ALU+}

TIMELESS DESIGN, PERFECT FOR EVERY MODERN ENVIRONMENT.



AUSTIN 6	
Item number	4431919
Base dimensions W × D	420 × 300 cm
Wall thickness	44 mm
Floor area	10.23 m ²
Capacity	24.48 m ³
Side wall height	239 cm
Ridge height	239 cm
Roof overhang	10 cm
Roof area	14 m ²
Glazed sliding door W × H	303.9 × 202.6 cm
Single window W × H	100.3 × 202.6 cm
Floor thickness	18.5 mm
Onduline, optional	3 ×

APPROPRIATE ACCESSORIES

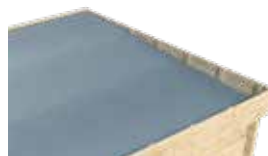

Onduline



Gutter

Other accessories can be found from page 126

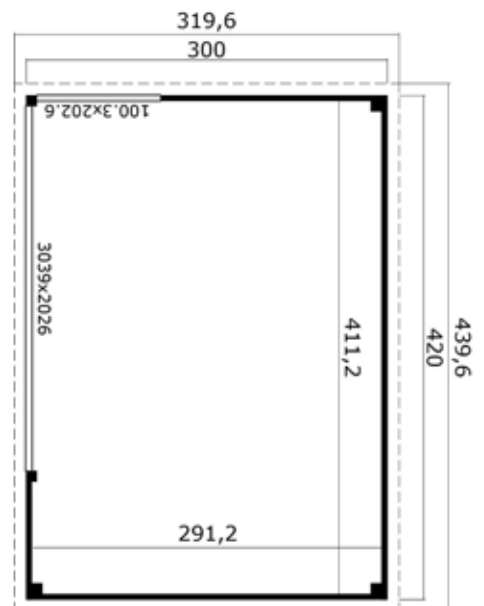



10.23 m² Austin 7



	AUSTIN 7
Item number	4433719
Base dimensions W × D	506 × 296 cm
Wall thickness	44 mm
Floor area	10,23 m ²
Capacity	24,48 m ³
Side wall height	239 cm
Ridge height	239 cm
Roof overhang	10 cm
Roof area	14 m ²
Glazed sliding door W × H	204,1 × 202,6 cm
Single window W × H	60 × 183,2 cm
Single window W × H	120 × 65 cm
Floor thickness	18.5 mm
Onduline, optional	3 ×

APPROPRIATE ACCESSORIES

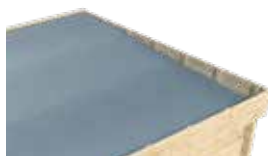

Onduline



Gutter

Other accessories
can be found from page 126

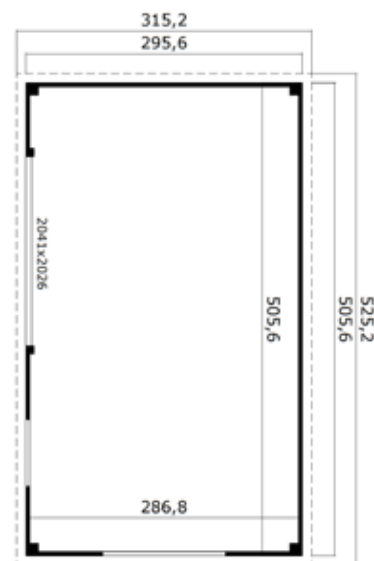

AUSTIN 7

NEW!



Additional
transverse window

AUSTIN 7 ALU+
**LARGE GLASS DOOR
AND TWO WINDOWS
- FOR A BRIGHT,
SPACIOUS FEEL.**



NEW!

Austin 7



MURANO 1 ALU +

BEAUTIFUL MODEL FOR A COSY OUTDOOR FEEL.



	MURANO 1
Item number	4428619
Base dimensions W × D	390 × 410 cm
Wall thickness	44 mm
Floor area	15.29 m ²
Capacity	42.72 m ³
Side wall height	228 cm
Ridge height	331 cm
Roof overhang	100 cm
Roof area	26.52 m ²
Double door W × H	159 × 198 cm
Single door W × H	84 × 190 cm
Single window W × H	60 × 183 cm
Double window W × H	117 × 183 cm
Floor thickness	18.5 mm
Roof covering, optional	3 × 15 m
Roof shingles, optional (pack)	10

APPROPRIATE ACCESSORIES

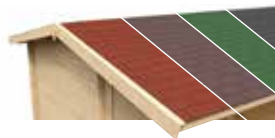

Roof shingles in various colours



Gutter

Other accessories can be found from page 126

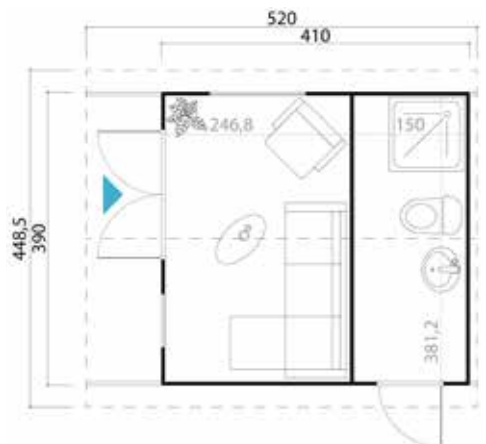



MURANO 2 ALU+

DECORATIVE CABIN WITH PRACTICAL SLEEPING LOFT.



	MURANO 2
Item number	4429719
Base dimensions W × D	410 × 300 cm
Wall thickness	44 mm
Floor area	11.68 m ²
Capacity	35.96 m ³
Side wall height	251 cm
Ridge height	365 cm
Roof overhang	18 cm
Roof area	18.49 m ²
Glazed sliding door W × H	304 × 203 cm
Single window W × H	60 × 183 cm
Floor thickness	18.5 mm
Roof covering, optional	1 × 15 m + 2 × 10 m
Roof shingles, optional (pack)	8
Glass panel, sliding	3

APPROPRIATE ACCESSORIES

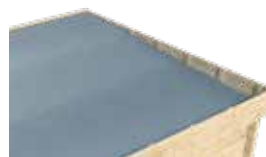

Onduline

Other accessories can be found from page 126

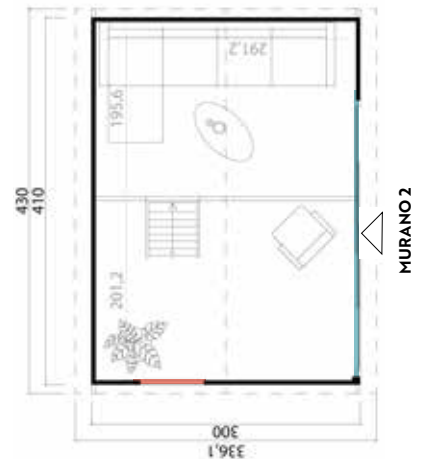
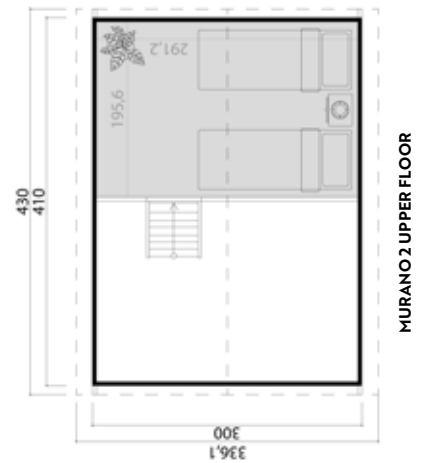



21.6 m²



MURANO 3	
Item number	4428719
Base dimensions W × D	390 × 575 cm
Wall thickness	44 mm
Floor area	21.58 m ²
Capacity	66.43 m ³
Side wall height	251 cm
Ridge height	365 cm
Roof overhang	28 cm
Roof area	30.94 m ²
Glazed sliding door W × H	304 × 203 cm
Glazed sliding door W × H	204 × 203 cm
Single door W × H	84 × 190 cm
Aluminium window size W × H	66.8 × 66.8 cm
Floor thickness	18.5 mm
Roof covering, optional	3 × 15 m
Roof shingles, optional (pack)	12
Glass panel, sliding	8

APPROPRIATE ACCESSORIES

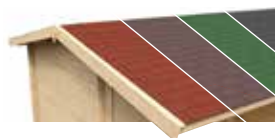

Roof shingles
in various colours



Premium roofing paper



Gutter

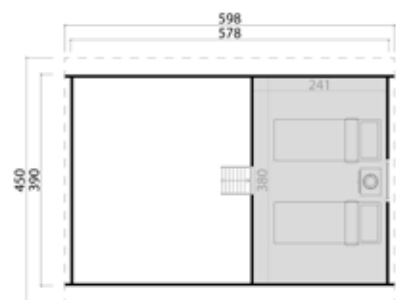

MURANO 3 UPPER FLOOR

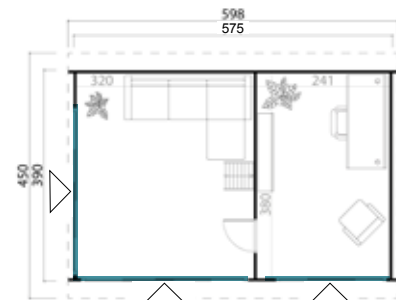

MURANO 3

Other accessories
can be found from page 126



With sleeping loft

MURANO 3 ALU+

SPACIOUS MODEL FOR ENJOYING AN AFTERNOON TEA – AND FOR AMBITIOUS GARDEN PROJECTS.



Metal roof
and corner covers

Premium windows and doors in
aluminium with insulated glazing

5.8 m²

Sardinia 2

SARDINIA ALU+

MODERN GARDEN CABIN WITH A LOT OF ROOM IN A SMALL SPACE.



	SARDINIA 1	SARDINIA 2
Item number	4429419	4429519
Base dimensions W × D	250 × 250 cm	350 × 250 cm
Wall thickness	44 mm	44 mm
Floor area	5.82 m ²	8.23 m ²
Capacity	13.93 m ³	19.7 m ³
Side wall height	239 cm	239 cm
Ridge height	239 cm	239 cm
Roof area	5.81 m ²	8.51 m ²
Single door W × H	84 × 198 cm	84 × 198 cm 84 × 190 cm
Single window W × H	120 × 60 cm	120 × 60 cm
Floor thickness	18.5 mm	18.5 mm
Onduline, optional	2 ×	2 ×

APPROPRIATE ACCESSORIES

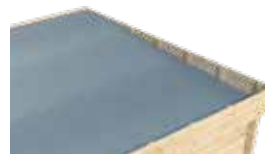

Onduline



Gutter

Other accessories
can be found from page 126



8.2 m² Sardinia 1





SARDINIA 3

Item number	4429619
Base dimensions W x D	500 x 250 cm
Wall thickness	44 mm
Floor area	11.85 m ²
Capacity	27.35 m ³
Side wall height	239 cm
Ridge height	239 cm
Roof area	12.27 m ²
Glazed double door W x H	158 x 198 cm
Single door W x H	83 x 190 cm
Single window W x H	120 x 60 cm
Floor thickness	18.5 mm
Onduline, optional	3 x

APPROPRIATE ACCESSORIES



Onduline



Bar unit

Other accessories
can be found from page 126



SARDINIA 3 ALU+

PENT ROOF MODEL WITH LARGE DOUBLE DOOR – FOR A CONTEMPORARY LIFESTYLE IN THE GARDEN.

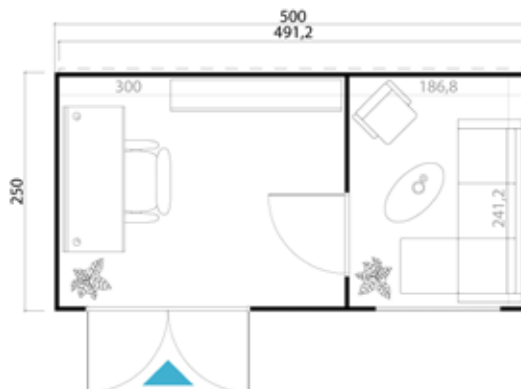





DOMEO RANGE.

GARDEN CABINS REDEFINED. MODERN,
CONTEMPORARY, HIGHLY FUNCTIONAL.

14

MODELS

04

COLOURS

02

WALL
THICKNESSES



Optionally available with custom-made interior sets in two sizes, also adaptable to our other garden cabins.

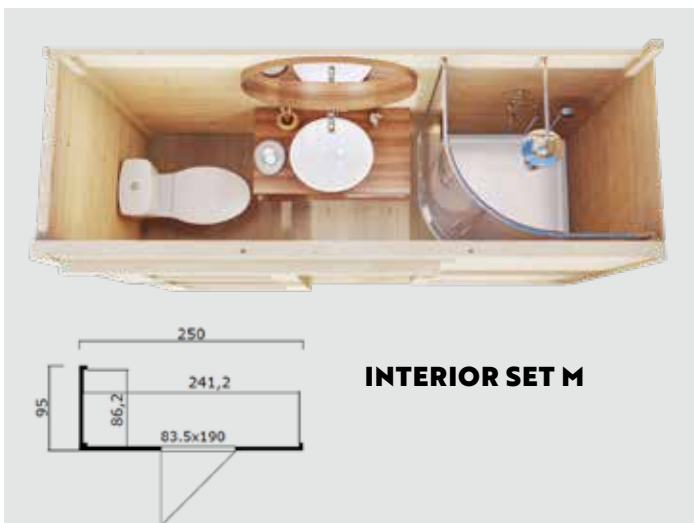
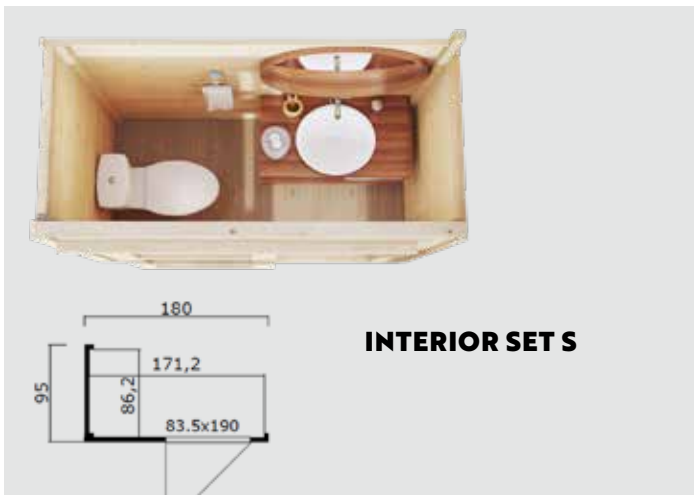

Add a second room to your garden cabin as an interior set, such as a bathroom, closet or store room. Available in two sizes. Perfect for cubic models, but can also be adapted to other garden buildings (taking into account interior space and roof height).
With practical, space-saving sliding door with opaque frosted glass.

Key facts

**SPRUCE
44 / 70 MM**

**DOUBLE TONGUE AND GROOVE
IMPREGNATED SUBSTRUCTURE**

**FLOORBOARDS 18.5 / 28 MM
ROOF BOARDS 18.5 MM**

SAFETY GLASS

DOUBLE GLAZING

**U-VALUE WINDOW /
DOOR 3.045**

DOMEO RANGE. ULTRAMODERN DESIGN WITH HUGE WINDOW AND DOOR FRONTS.

This exceptionally stylish garden cabin series is characterised by room-height window fronts with large lockable sliding doors, accented with colour-matching aluminium trim.

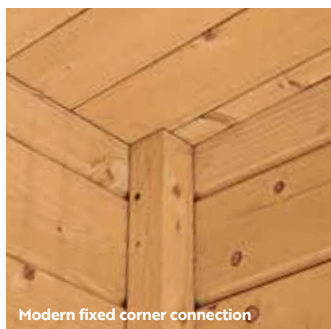
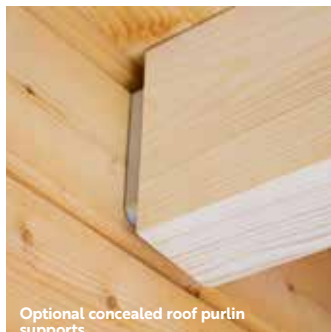

CONSTRUCTION

1	Wall thickness mm	44 / 70
2	Double tongue and groove	+
3	Wall insulation	Optional
4	Impregnated substructure	+
5	Floorboards	18 / 28 mm

ROOF CONSTRUCTION

6	Roof boards	18.5 mm
7	Roof construction	Roof purlins



SAFETY GLASS

SLIDING DOORS AND WINDOW FAÇADE

	Material	Aluminium
1	Frame thickness mm	22
2	Cladding	Powder-coated aluminium
3	Safety glass	Double (4 / 6 / 4)
	U-value > W / m ² K	3.045
4	Rubber seal	+
5	Door threshold	Aluminium / coated metal
	Door opening	Sliding door
6	Lock	Multi-point locking system



SAFETY GLASS



8.5 m²

Domeo 1



SNAP & WATCH



Domeo MINI

DOMEO 1 ALU+ MODERN ROOMS FOR SMALL GARDENS.



	DOMEO 1
Item number	4423619
Base dimensions W × D	300 × 300 cm
Wall thickness	44 mm
Floor area	8.48 m ²
Capacity	19.58 m ³
Side wall height	239 cm
Ridge height	239 cm
Roof overhang	10 cm
Roof area	9.59 m ²
Glazed sliding door W × H	204 × 203 cm
Single window W × H	100 × 203 cm
Floor thickness	18.5 mm
Onduline, optional	3 ×
Glass panel, sliding ●	2
Glass panel, fixed ●	1

APPROPRIATE ACCESSORIES



Onduline



Gutter



DOMEO 1

Other accessories can be found from page 126

Roof extension can be fitted on the right or left in the natural version



14.3 m² Domeo 2



SNAP & WATCH

DOMEO 2 ALU+

PRACTICAL ROOF EXTENSION FOR OUTDOOR ENJOYMENT SHIELDED FROM THE RAIN.



	DOMEO 2
Item number	4423719
Base dimensions W × D	300/524 × 300 cm
Wall thickness	44 mm
Floor area	8.48 m ²
Capacity	19.58 m ³
Side wall height	239 cm
Ridge height	239 cm
Roof overhang	200 cm
Roof area	15.71 m ²
Glazed sliding door W × H	204 × 203 cm
Single window W × H	100 × 203 cm
Floor thickness	18.5 mm
Onduline, optional	4 ×
Glass panel, sliding ●	2
Glass panel, fixed ●	1



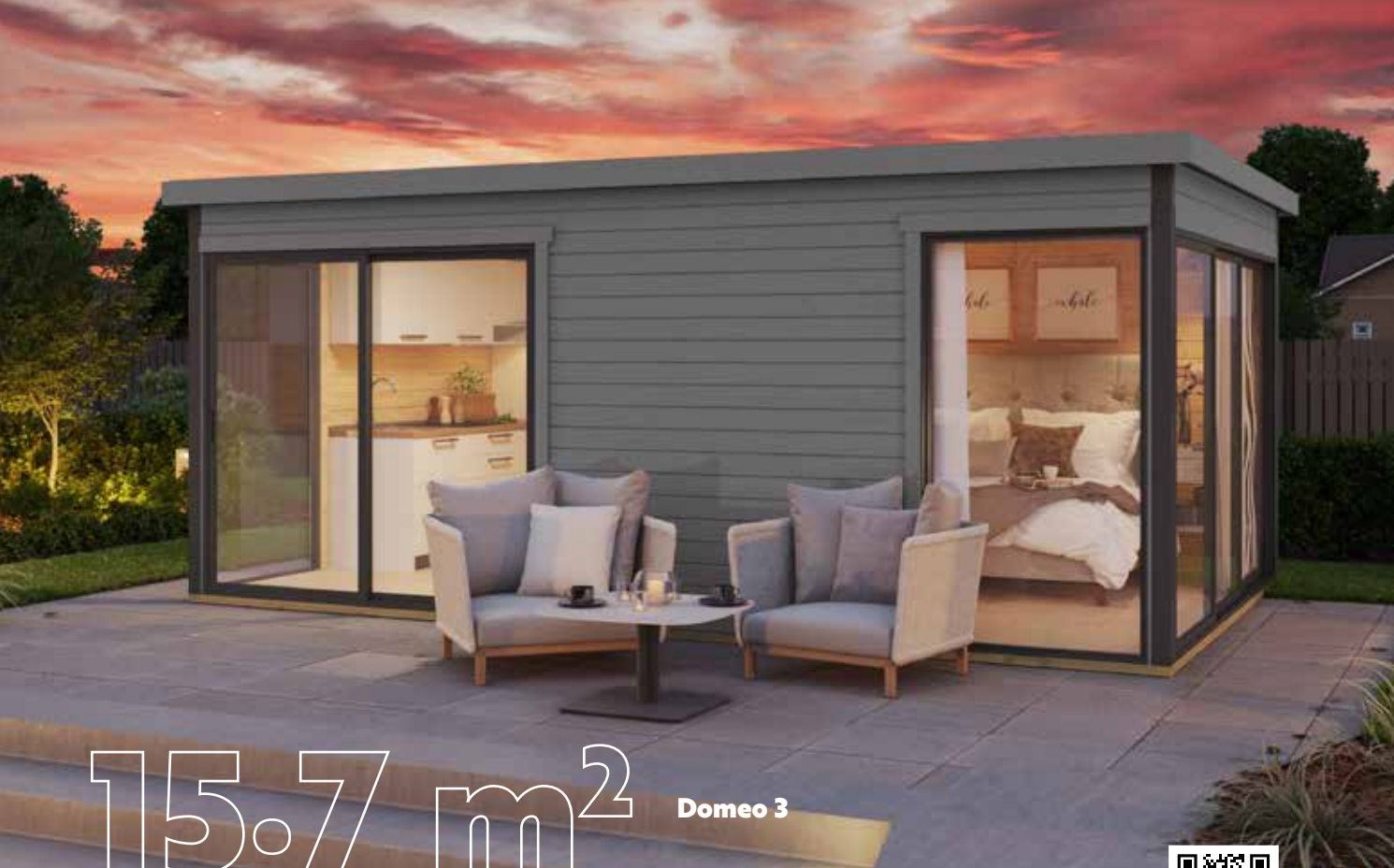

15.7 m² Domeo 3



SNAP & WATCH

DOMEO 3 ALU +

INDOORS AND OUTDOORS – THANKS TO LIGHT-FLOODED ROOMS.



Domeo 3 with optional roof extension



	DOMEO 3	ROOF EXTENSION
Item number	4423819	9901200
Base dimensions W × D	509 × 322 cm	300 × 322 cm
Wall thickness	44 mm	–
Floor area	15.67 m ²	9.30 m ²
Capacity	36.17 m ³	–
Side wall height	239 cm	239 cm
Ridge height	239 cm	239 cm
Roof overhang	10 cm	10 cm
Roof area	17.18 m ²	9.75 m ²
Glazed sliding door W × H	304 × 203 cm	–
Glazed sliding door W × H	204 × 203 cm	–
Single door W × H	84 × 196 cm	–
Single window W × H	100 × 203 cm	–
Floor thickness	18.5 mm	–
Onduline, optional	4 ×	3 ×
Glass panel, sliding ●	5	–
Glass panel, fixed ●	2	–





SNAP & WATCH

DOMEO 3 LOGGIA ALU+

PRACTICAL TWO-ROOM CABIN INCLUDING COVERED TERRACE.



DOMEO 3 LOGGIA

Item number	4425819
Base dimensions W × D	509 × 322 cm
Roof dimensions W × D	609 × 422 cm
Wall thickness	44 mm
Floor area	22.80 m ²
Capacity	52.63 m ³
Side wall height	239 cm
Ridge height	239 cm
Roof overhang	80 cm
Roof area	24.47 m ²
Glazed sliding door W × H	304 × 203 cm
Glazed sliding door W × H	204 × 204 cm
Single door W × H	84 × 196 cm
Single window W × H	100 × 203 cm
Floor thickness	18.5 mm
Onduline, optional	6 ×
Glass panel, sliding	5
Glass panel, fixed	2

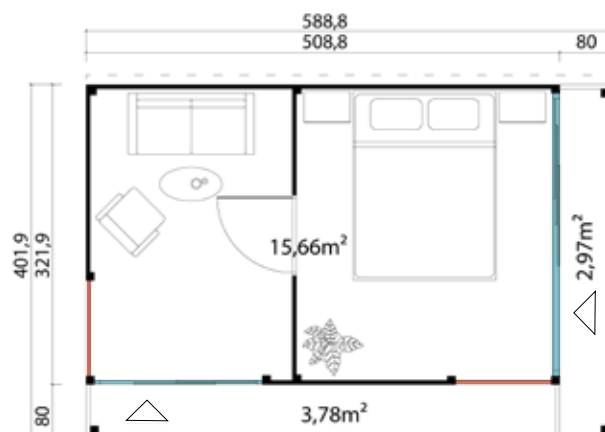



DOMEO 4 ALU +

MODERN GARDEN CABIN WITH LARGE WINDOW FAÇADE.



SNAP & WATCH



Domeo 4 with optional roof extension



	DOMEO 4	ROOF EXTENSION
Item number	4424019	9901200
Base dimensions W × D	418 × 322 cm	300 × 322 cm
Wall thickness	44 mm	–
Floor area	12.82 m ²	9.30 m ²
Capacity	29.59 m ³	–
Side wall height	239 cm	239 cm
Ridge height	239 cm	239 cm
Roof overhang	10 cm	10 cm
Roof area	14.22 m ²	9.75 m ²
Glazed sliding door W × H	400 × 203 cm	–
Glazed sliding door W × H	204 × 203 cm	–
Floor thickness	18.5 mm	–
Onduline, optional	4 ×	3 ×
Glass panel, sliding	6	–





22.4 m²

Domeo 4 Loggia



SNAP & WATCH

DOMEO 4 LOGGIA ALU+

CONTINUOUS GLASS FAÇADE WITH COVERED TERRACE.



DOMEO 4 LOGGIA

Item number	4425919
Base dimensions W × D	418 × 322 cm
Roof dimensions W × D	598 × 422 cm
Wall thickness	44 mm
Floor area	22.38 m ²
Capacity	51.65 m ³
Side wall height	239 cm
Ridge height	239 cm
Roof overhang	80 cm
Roof area	24.46 m ²
Glazed sliding door W × H	400 × 203 cm
Floor thickness	18.5 mm
Onduline, optional	6 ×
Glass panel, sliding	4

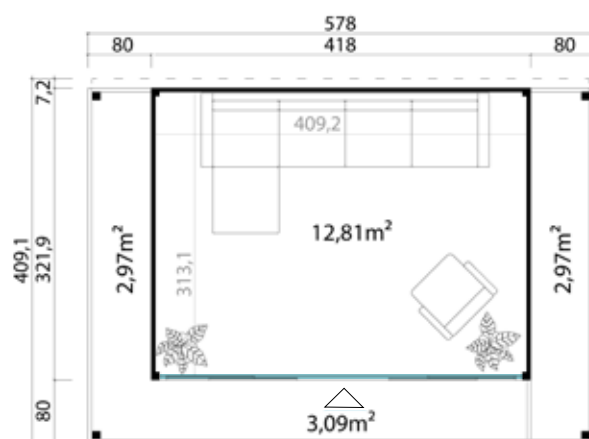



16.7 m²

Domeo 5



1. Sliding door with aluminium frame
2. Metal edge protector



Item number

DOMEO 5

4424119

ROOF EXTENSION

9900300

Base dimensions W × D

418 × 418 cm

300 × 418 cm

Wall thickness

44 mm

–

Floor area

16.74 m²

12.10 m²

Capacity

40.09 m³

–

Side wall height

239 cm

239 cm

Ridge height

239 cm

239 cm

Roof overhang

10 cm

10 cm

Roof area

18.38 m²

12.60 m²

Glazed sliding door W × H

400 × 203 cm

–

Glazed sliding door W × H

204 × 203 cm

–

Floor thickness

18.5 mm

–

Onduline, optional

5 ×

3 ×

Glass panel, sliding

8

–

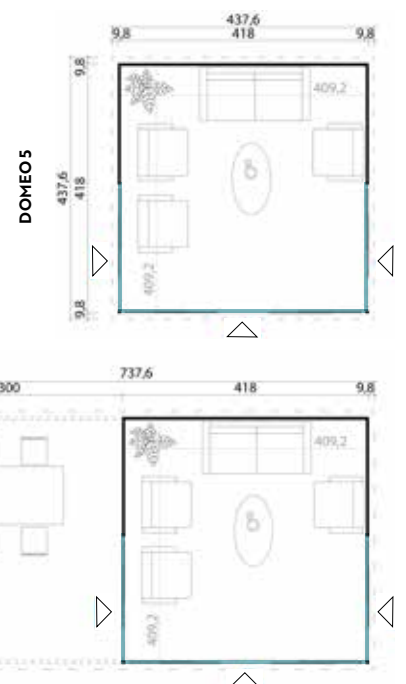

Optional roof extension can be installed on right or left in the natural version



SNAP & WATCH

DOMEO 5 ALU+

LARGE GLASS PANELS ON THREE SIDES PROVIDE A MAXIMUM FEELING OF SPACE IN YOUR GARDEN CABIN.



17.9 m² Domeo 6

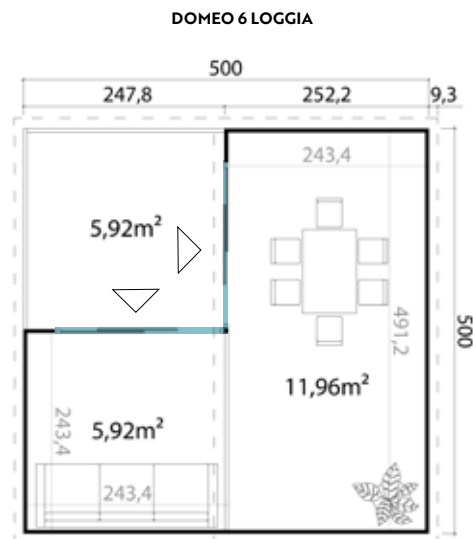
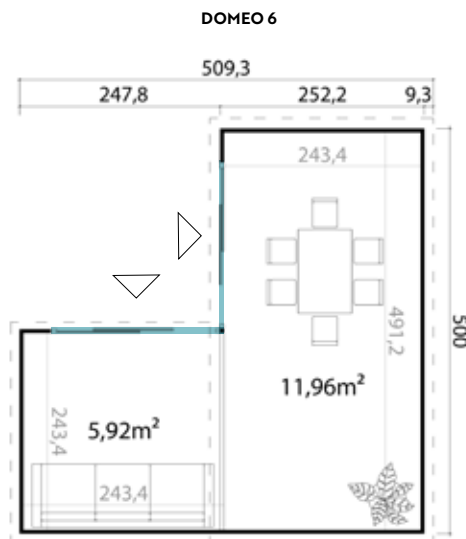



DOMEO 6 ALU+

DOMEO 6 LOGGIA ALU+

**IDEAL FOR A CORNER
IN THE GARDEN.
FLOODED WITH LIGHT
AND PLENTY OF SPACE.**

	DOMEO 6	DOMEO 6 LOGGIA
Item number	4424919	4426019
Base dimensions W × D	500 × 500 cm	500 × 500 cm
Wall thickness	44 mm	44 mm
Floor area	17.90 m ²	17.90 m ²
Capacity	58.45 m ³	58.45 m ³
Side wall height	251 cm	251 cm
Ridge height	251 cm	251 cm
Roof overhang	10 cm	10 cm
Roof area	18.97 m ²	26.26 m ²
Glazed sliding door W × H	204 × 203 cm	204 × 203 cm
Floor thickness	18.5 mm	18.5 mm
Onduline, optional	5 ×	6 ×
Glass panel, sliding	4	4



SNAP & WATCH



17.9 m² Domeo 6 Loggia



11.4 m²

Domeo 7



SNAP & WATCH

DOMEO 7 ALU+

MODERN LOOK, LARGE WINDOWS AND A COVERED SEATING AREA FOR RAINY DAYS.



DOMEO 7

Item number	4426619
Base dimensions W × D	400/605 × 300 cm
Wall thickness	44 mm
Floor area	11.39 m ²
Capacity	28.57 m ³
Side wall height	239 cm
Ridge height	251 cm
Roof overhang	80 cm
Roof area	23.60 m ²
Glazed double door W × H	159 × 198 cm
Single window W × H	60 × 183 cm
Double window W × H	117 × 183 cm
Floor thickness	18.5 mm
Onduline, optional	6 ×

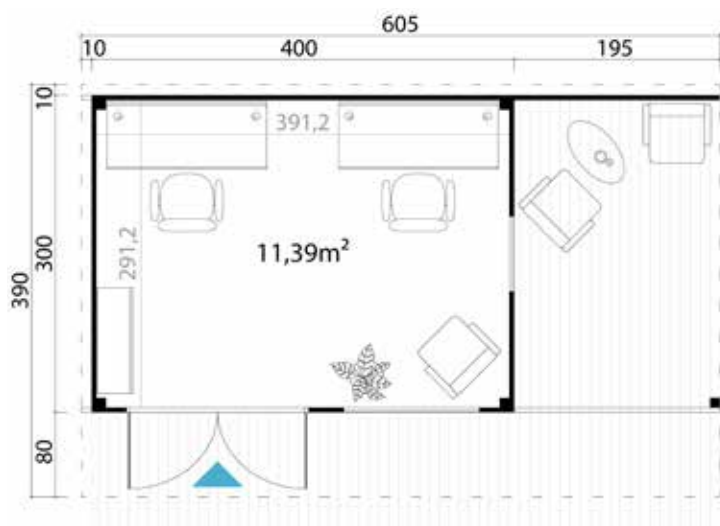



19.2 m²

DOMEO 8



SNAP & WATCH

DOMEO 8 ALU+

ULTRAMODERN DESIGN WITH 28 MM THICK DOUBLE GLAZED BI-FOLD DOORS.



	DOMEO 8
Item number	4426719
Base dimensions W × D	500/560 × 400 cm
Wall thickness	44 mm
Floor area	19.22 m ²
Capacity	46 m ³
Side wall height	239 cm
Ridge height	239 cm
Roof overhang	80 cm
Roof area	26.90 m ²
Glazed bi-fold door W × H	250 × 198 cm
2 × single window W × H	60 × 183 cm
Floor thickness	18.5 mm
Onduline, optional	7 ×

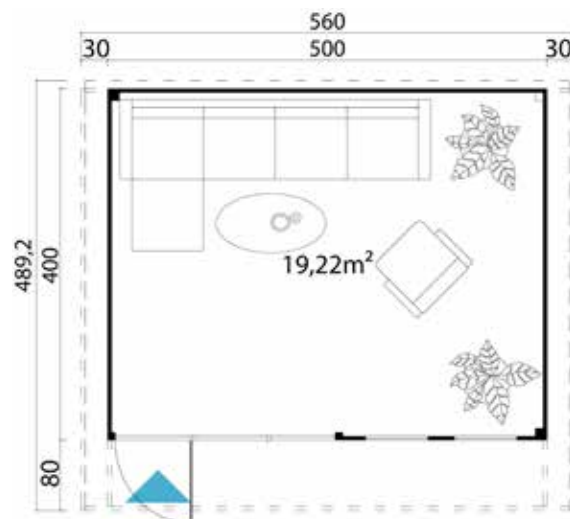

DOMEO 9 ALU+

CONTEMPORARY DESIGN WITH BI-FOLD DOOR GLASS FRONT.



	DOMEO 9	DOMEO 10
Item number	7015641	7015741
Base dimensions W × D	450 × 450 cm	450/850 × 450 cm
Wall thickness	70 mm	70 mm
Floor area	19 m ²	19 + 28 m ²
Capacity	47.83 m ³	91.71 m ³
Side wall height	245 cm	245 cm
Ridge height	261 cm	262 cm
Roof overhang	120 cm	120 cm
Roof area	34.81 m ²	52.51 m ²
2 × glazed bi-fold door W × H	340 × 198 cm	340 × 198 cm
Floor thickness	28 mm	28 mm
Onduline, optional	9 ×	13 ×



19 m² Domeo 9



SNAP & WATCH



19 + 28 m²

Domeo 10



SNAP & WATCH

DOMEO 10 ALU+

**WHEN YOU NEED A LITTLE MORE LUXURY:
CORNER DOOR DESIGN WITH LARGE
COVERED OUTDOOR AREA.**

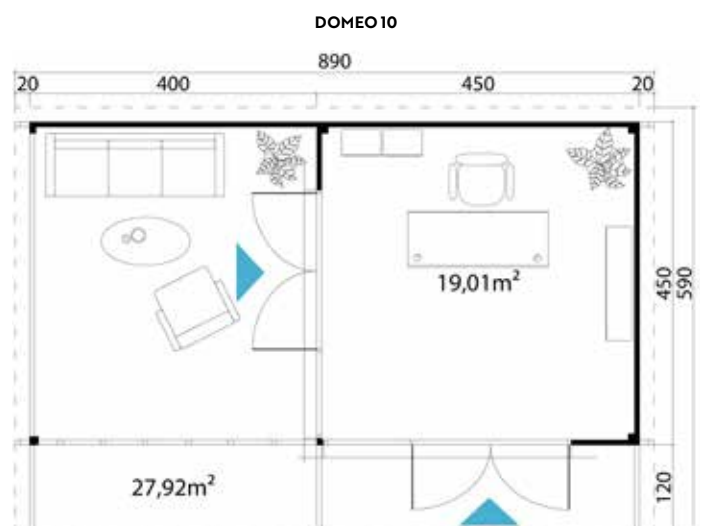
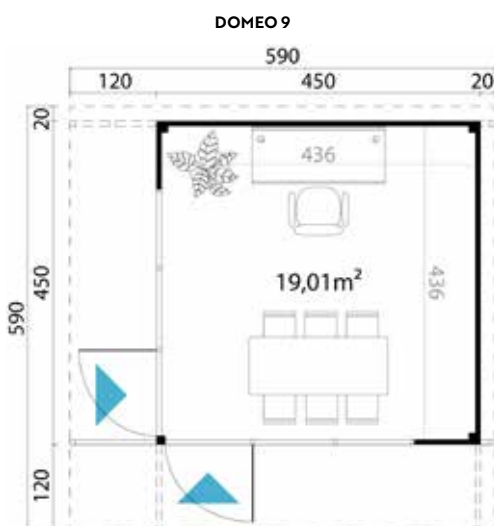

DOMEO 11 ALU+

UNADORNED MODEL WITH TWO SEPARATE ROOMS AND LARGE GLASS FRONTS.



	DOMEO 11
Item number	4429219
Base dimensions W × D	500 × 595 cm
Wall thickness	44 mm
Floor area	20.83 m ²
Capacity	52.05 m ³
Side wall height	251 cm
Ridge height	251 cm
Roof overhang	10 cm
Roof area	21.75 m ²
2x glazed sliding door W × H	204 × 203 cm
Glazed sliding door W × H	304 × 203 cm
Single door W × H	84 × 190 cm
Floor thickness	18.5 mm
Onduline, optional	9 ×
Glass panel, sliding ●	7





3 glazed sliding doors

Metal corner-covers

20.8 m²

Domeo 11



APPROPRIATE ACCESSORIES

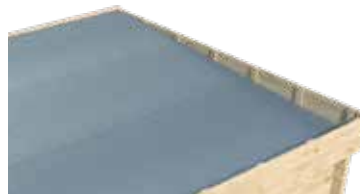

Onduline



Gutter

Other accessories can be found from page 126



GARDEN CABINS.

PERFECT FOR LIVING, WORKING,
RELAXATION OR KEEPING FIT.

43

MODELS

04

COLOURS

05

WALL
THICKNESSES



05
-YEAR
WARRANTY
ON THE CONSTRUCTION



CONSTRUCTION	
1 Wall thickness mm	28 / 34 / 40 / 44
2 Double tongue and groove Wind-tight chalet connection	From 34 mm +
3 Wind protection	Threaded rod or storm strip
4 Wall insulation	Depends on the model, optional
5 Impregnated substructure	+
6 Floorboards	15,5 or 18.5 mm
ROOF CONSTRUCTION	
7 Roof boards	15,5 or 18.5 mm
8 Roof construction	Roof purlins



Key facts

SPRUCE
28 / 34 / 40 / 44 / 70 MM

DOUBLE TONGUE AND GROOVE FROM 34 MM

IMPREGNATED SUBSTRUCTURE

FLOORBOARDS 15.5 / 18.5 MM
ROOF BOARDS 15.5 / 18.5 MM

SAFETY GLASS

U-VALUE WINDOW / DOOR 5.6 / 3.3



GARDEN CABINS. SOLID, ROBUST AND PROCESSED WITH CARE IN EVERY RESPECT.

The classic log construction method has been tried and tested for centuries and is ideally suited to wood buildings for every conceivable use – from a small tool shed to an inviting garden cabin. The range of technical specifications is correspondingly broad but they are all characterised by their extremely robust and durable construction.

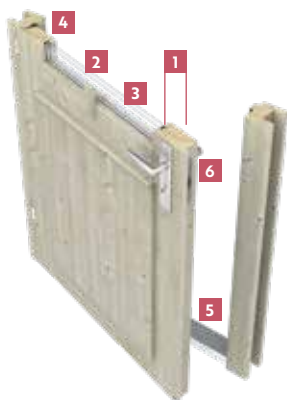
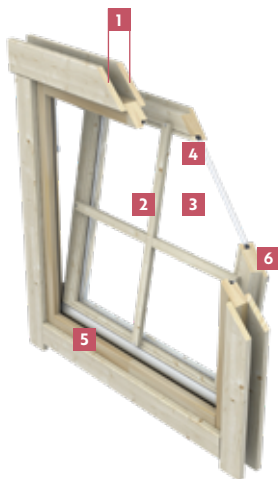

WINDOW

Wood type glued wood	Untreated spruce
1 Profile thickness mm	28 / 34 / 40 / 44
2 Mullions	(With) screws
3 Safety glass	Single (4 mm) or double (4 / 6 / 4)
U-value > W / m ² K	5.6 or 3.3
4 Rubber seal	Depending on model
5 Drip cap	Wood / aluminium
Window opening	Inwards or inwards / outwards
6 Opening system	2-hand tilt&turn



SAFETY GLASS

DOORS

Wood type glued wood	Untreated spruce
1 Profile thickness mm	28 / 34 / 40 / 44
2 Mullions	(With) screws
3 Safety glass	Single (4 mm) or double (4 / 6 / 4)
U-value > W / m ² K	5.6 or 3.3
4 Rubber seal	Depending on model
5 Door threshold	Aluminium / coated metal
Door opening	Exterior
6 Lock	Cylinder



SAFETY GLASS



OPTIMISED QUALITY – PROVEN PRODUCTS MADE EVEN BETTER.

We have optimised the proven quality of our windows and doors. Please note the corresponding symbol for the respective cabins:



BRONZE

How you benefit

Windows:

- Single glazing 4 mm
- Window frame in glued spruce, pre-installed
- Window drip cap in wood
- Window openings inward
- Fittings not pre-installed
- Code: SGA

Door:

- Door frame not pre-installed
- Door frame in glued spruce
- Including pre-installed screw-on hinges and simple locks
- Door incl. cylinder lock
- Door threshold on selected models in aluminium
- Outward-opening doors
- Code: SGA/TA



SNAP &
WATCH

SILVER

How you benefit

Windows:

- Single glazing 4 mm
- Window frame in glued spruce, pre-installed
- Window drip cap in wood
- Window openings inward
- Fittings pre-installed
- Code: SGC/MGC

Door:

- Door frame pre-installed
- Door frame in double-glued spruce
- Including pre-installed screw-in hinges and milled locks
- Door incl. cylinder lock
- Door threshold on selected models in aluminium
- Outward-opening doors
- Code: SGC/MGC/TC



SNAP &
WATCH

GOLD

How you benefit

Windows:

- Double-glazed safety glass on selected models
- Window frame in glued spruce, pre-installed
- Window drip cap in aluminium
- Windows equipped with seals
- Tilt&turn windows open inwards
- Fittings pre-installed
- Code: DGP+

Door:

- Door frame pre-installed
- Door frame in double-glued spruce
- Including pre-installed screw-in hinges and milled locks
- Hinges adjustable in three directions
- Door incl. cylinder lock
- Door threshold in aluminium
- Doors equipped with seals
- Outward-opening doors
- Code: DGP+/TP+



SNAP &
WATCH



PLATINUM

How you benefit

Windows:

- Double glazing
- Window frame in glued pine, pre-installed
- Window drip cap in aluminium
- Windows equipped with seals
- Tilt&turn windows open inwards
- Solid fittings pre-installed
- Including drip cap in coated metal
- Code: 2+

Door:

- Double glazing
- Door frame pre-installed
- Door frame in glued pine
- Door leaf with sturdy double-cassette panels
- Including pre-installed screw-in hinges and milled locks
- Hinges adjustable in three directions, with attractive caps
- Door including cylinder lock
- Door threshold in coated metal
- Doors equipped with seals
- Outward-opening doors
- Code: 2+



SNAP &
WATCH



How you benefit

Windows:

- Double glazing
- Window frame in glued pine, pre-installed
- Window drip cap in aluminium
- Windows equipped with seals
- Glazing bar attachment with clips on selected models
- 1-hand tilt&turn windows open inwards
- Solid fittings pre-installed
- Including drip cap in coated metal
- Code: 3+



**SNAP &
WATCH**

Door:

- Double glazing
- Door frame pre-installed
- Door frame in glued pine
- Door leaf with sturdy double-cassette panels
- Including pre-installed screw-in hinges and milled locks
- Hinges adjustable in three directions, with attractive caps
- Door incl. cylinder lock and multi-point locking system
- Door threshold in coated metal
- Doors equipped with seals
- Outward-opening doors
- Code: 3+



Tilt&turn window

SICILY 1 ^{GOLD}

SMALL GARDEN BLISS, BIG IN DESIGN.

Sicily 1 with optional roof extension, can be installed on right or left



	SICILY 1	ROOF EXTENSION
Item number	4428802	9907500
Base dimensions W x D	410 x 350 cm	300 x 350 cm
Wall thickness	44 mm	44 mm
Floor area	13.69 m ²	9.94 m ²
Capacity	31.21 m ³	22.65 m ³
Side wall height	217 cm	217 cm
Ridge height	228 cm	228 cm
Roof overhang	80 cm	80 cm
Roof area	14.96 m ²	13.64 m ²
Glazed double door W x H	149 x 190 cm	—
2x large single window W x H	56 x 178 cm	—
Floor thickness	18.5 mm	—
Onduline, optional	4 x	3 x



APPROPRIATE ACCESSORIES



Gutter

Other accessories can be found from page 126



19.3 m²

SICILY 2 GOLD

STYLISH OUTDOOR ROOM – WITH EXTRA STORAGE SPACE.



	SICILY 2	ROOF EXTENSION
Item number	4428902	9907500
Base dimensions W × D	575 × 350 cm	300 × 350 cm
Wall thickness	44 mm	44 mm
Floor area	19.32 m ²	9.94 m ²
Capacity	44.05 m ³	22.65 m ³
Side wall height	217 cm	217 cm
Ridge height	228 cm	228 cm
Roof overhang	80 cm	80 cm
Roof area	26.18 m ²	13.64 m ²
Glazed double door W × H	149 × 190 cm	—
Single door W × H	83 × 190 cm	—
2x large single window W × H	56 × 178 cm	—
Floor thickness	18.5 mm	—
Onduline, optional	6 ×	3 ×

APPROPRIATE ACCESSORIES



Gutter

Other accessories can be found from page 126



Sicily 2 with optional roof extension, can be installed on right or left



SICILY 2



SICILY 2 WITH ROOF EXTENSION

Space-saving corner entrance

Premium window with double glazing

4.8 m²



SNAP & WATCH

OBAN GOLD

MODERN CABIN, PERFECT FOR A CORNER OF THE PLOT.



1. Strong adjustable hinges
2. Doorstop included



	OBAN 40
Item number	408940
Base dimensions W × D	240 × 240 cm
Wall thickness	40 mm
Floor area	4.80 m ²
Capacity	10.70 m ³
Side wall height	205 cm
Ridge height	241 cm
Roof overhang	21.40 cm
Roof area	8.30 m ²
Glazed double door W × H	149 × 174 cm
2 × single window W × H	53 × 156 cm
Floor thickness	18.5 mm
Roof covering, optional	1 × 15 m
Roof shingles, optional (pack)	5

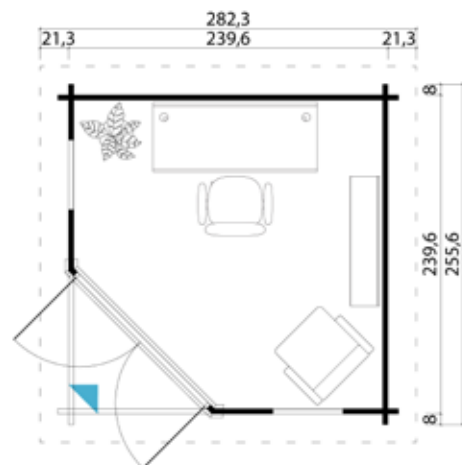

Reverse installation of natural cabin possible

Premium window with double glazing

Space-saving corner entrance

11.4 m²



SNAP & WATCH

EDINBURGH ^{GOLD}

MODERN, WITH SPACE-SAVING CORNER DOOR AND LIGHT-FLOODED INTERIOR.



EDINBURGH 2

Item number	407640
Base dimensions W × D	448 × 280 cm
Wall thickness	40 mm
Floor area	11.40 m ²
Capacity	26 m ³
Side wall height	205 cm
Ridge height	246 cm
Roof overhang	21.10 cm
Roof area	16.40 m ²
Glazed double door W × H	149 × 174 cm
3 × single window W × H	53 × 156 cm
Floor thickness	18.5 mm
Roof covering, optional	2 × 15 m
Roof shingles, optional (pack)	8

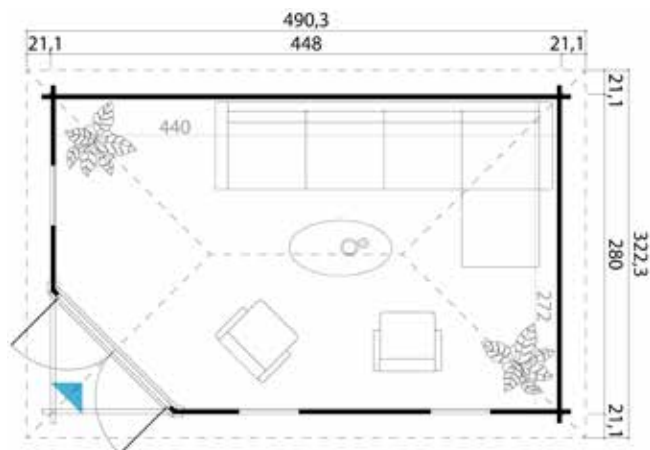

Reverse installation of natural cabin possible

Premium window with double glazing



18.9 m²

Dorset 3



Dorset 1



Dorset 2



Dorset 71



	DORSET 1	DORSET 2	DORSET 3	DORSET 71	DORSET 72	DORSET 73
Item number	348902	3419602	3419702	709502	709602	709702
Base dimensions W × D	390 × 250 cm	390 × 300 cm	500 × 390 cm	400 × 250 cm	450 × 250 cm	480 × 250 cm
Wall thickness	34 mm	34 mm	34 mm	70 mm	70 mm	70 mm
Floor area	9.30 m ²	11.24 m ²	18.90 m ²	9.11 m ²	10.29 m ²	11 m ²
Capacity	20.70 m ³	25.30 m ³	42.55 m ³	20.75 m ³	23.79 m ³	25.43 m ³
Side wall height	211 cm	211 cm	211 cm	224 cm	224.40 cm	224.40 cm
Ridge height	234 cm	239 cm	239 cm	239 cm	239 cm	239 cm
Roof overhang	50 cm	50 cm	50 cm	80 cm	80 cm	80 cm
Roof area	13.82 m ²	15.96 m ²	25.30 m ²	16.56 m ²	18.36 m ²	19.44 m ²
Glazed double door W × H	159 × 196 cm	159 × 196 cm	159 × 196 cm	158 × 193 cm	158 × 193 cm	158 × 193 cm
Single window W × H	56 × 178 cm	56 × 178 cm	56 × 178 cm	110 × 173 cm	110 × 173 cm	2 × 110 × 173 cm
Fixed window W × H	101 × 178 cm	101 × 178 cm	101 × 178 cm	—	55 × 173 cm	
Floor thickness	18.5 mm	18.5 mm	18.5 mm	18.5 mm	18.5 mm	18.5 mm
Roof covering, optional	2 × 10 m	2 × 15 m	2 × 15 m	2 × 10 m	2 × 15 m	3 × 15 m
Onduline, optional	4 ×	5 ×	7 ×	4 ×	5 ×	5 ×



Fixed glass panel

DORSET GOLD
**MODERN DESIGN,
 DOUBLE DOORS
 AND LARGE
 WINDOWS – FOR A
 PERFECT WORKING
 ATMOSPHERE IN
 YOUR OWN GARDEN.**

**Dorset 71–73
 NOW IN
 4 COLOURS!**



Dorset 72



Dorset 73

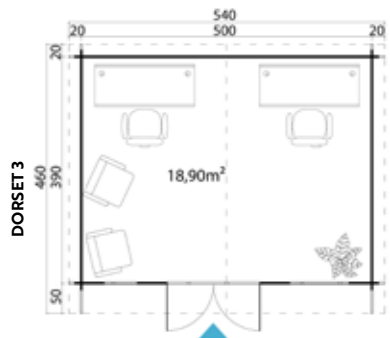
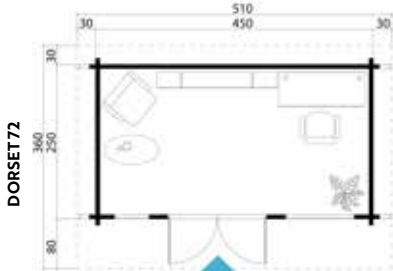
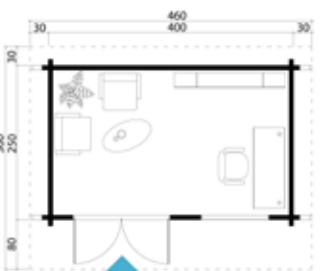
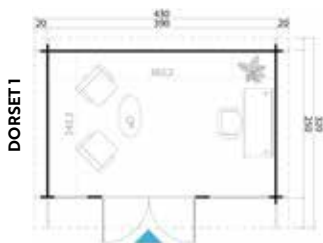



Premium windows
with double glazing

19.7 m² Sussex 2



	SUSSEX 1	SUSSEX 2
Item number	4425502.20	4425602.20
Base dimensions W × D	390 × 300 cm	570 × 360 cm
Wall thickness	44 mm	44 mm
Floor area	11.10 m ²	19.71 m ²
Capacity	24.99 m ³	44.38 m ³
Side wall height	211 cm	211 cm
Ridge height	239 cm	239 cm
Roof overhang	80 cm	80 cm
Roof area	18.60 m ²	30.20 m ²
Glazed bi-fold door W × H	260 × 196 cm	260 × 196 cm
2 × single window W × H	—	56 × 178 cm
Floor thickness	18.5 mm	18.5 mm
Roof covering, optional	3 × 10 m	3 × 15 m
Onduline, optional	5 ×	8 ×

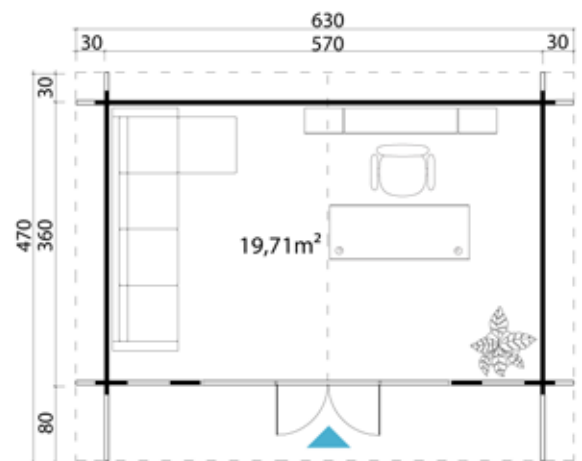

SUSSEX 2



SUSSEX PLATINUM

DOUBLE BI-FOLD DOORS PROVIDE MAXIMUM SPACE AND SUFFICIENT ACCESS TO THE GARDEN.



SNAP & WATCH



SUSSEX 1



Sussex 1

APPROPRIATE ACCESSORIES

Other accessories can be found from page 126

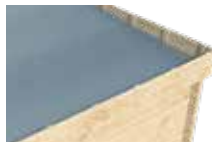

Onduline



Lean-to shed



Bar unit



ANDERS

Item number	4420802
Base dimensions W × D	360 × 360 cm
Wall thickness	44 mm
Floor area	12.33 m ²
Capacity	28.12 m ³
Side wall height	222 cm
Ridge height	234 cm
Roof overhang	28 cm
Roof area	28.55 m ²
2 × double door W × H	159 × 196 cm
Single window W × H	56 × 178 cm
Floor thickness	18.5 mm
Roof covering, optional	3 × 15 m
Onduline, optional	7 ×

APPROPRIATE ACCESSORIES



Onduline



Bar unit

Other accessories
can be found from page 126



ANDERS GOLD

**ULTRAMODERN, BRIGHT GARDEN CABIN
WITH COVERED TERRACE:
A LIVING ROOM IN THE GARDEN.**



Premium window with double glazing

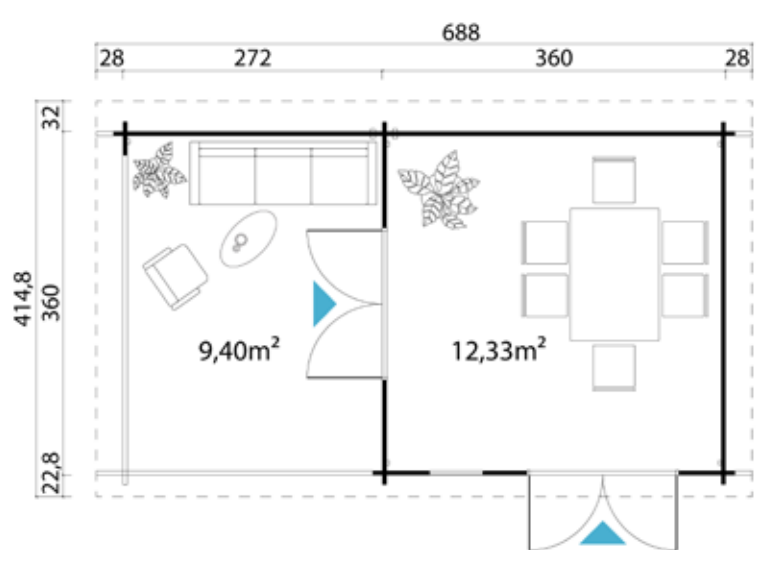



SNAP & WATCH

JAVA GOLD

SOLID GARDEN CABIN WITH THREE ROOMS. GALVANISED ROOF EDGING ENSURES A PREMIUM LOOK.



	JAVA
Item number	4415802
Base dimensions W × D	608 × 390 cm
Wall thickness	44 mm
Floor area	22.80 m ²
Capacity	53.40 m ³
Side wall height	234 cm
Ridge height	260 cm
Roof overhang	60 cm
Roof area	30.50 m ²
Glazed double door W × H	391 × 196 cm
2 × single door W × H	84 × 190 cm
Fixed window W × H	150 × 41 cm
Floor thickness	18.5 mm
Roof covering, optional	3 × 15 m
Onduline, optional	9 ×

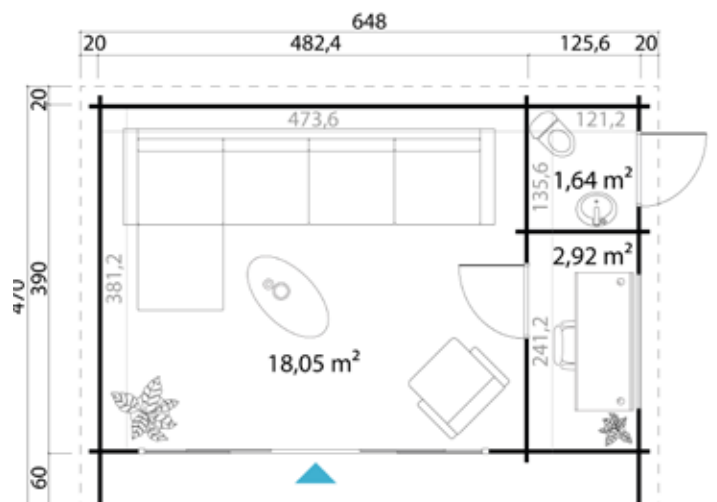



21.3 m²

LITTLE ROCK SILVER

COSY CABIN WITH COVERED ENTRY AND SEPARATE STORE ROOM.



LITTLE ROCK	
Item number	3411700
Base dimensions W x D	510 x 430 cm
Wall thickness	34 mm
Floor area	21.30 m ²
Capacity	45.52 m ³
Side wall height	182 cm
Ridge height	245 cm
Roof overhang	30 cm
Roof area	27.36 m ²
Double door W x H	159 x 185 cm
Single door W x H	84 x 190 cm
2 x single window W x H	88 x 65 cm
Floor thickness	18.5 mm
Roof covering, optional	3 x 15 m
Roof shingles, optional (pack)	11

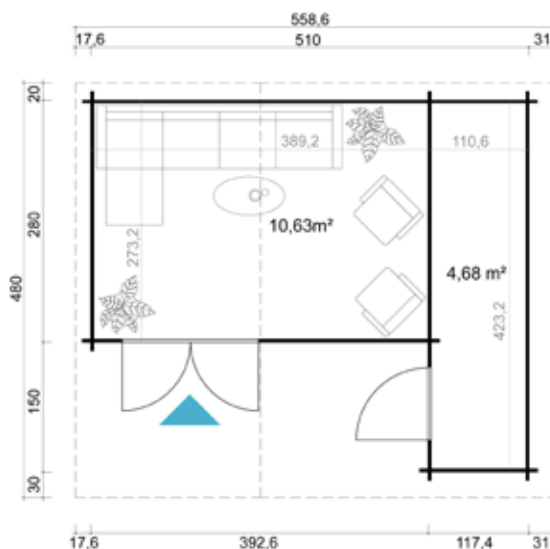

APPROPRIATE ACCESSORIES

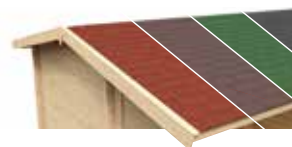

Roof shingles in various colours



Roof extension

Other accessories can be found from page 126

Reverse installation of natural cabin possible

Premium window with double glazing

Including impregnated terrace

18.5m² Brighton 44



	HAMPSHIRE	BRIGHTON 44
Item number	4423202	4416902
Base dimensions W × D	420 × 300 cm	520 × 370 cm
Wall thickness	44 mm	44 mm
Floor area	11.97 m ²	18.46 m ²
Capacity	26.28 m ³	35.00 m ³
Side wall height	200 cm	211 cm
Ridge height	239 cm	251 cm
Roof overhang	38 cm	30 cm
Roof area	18.72 m ²	25.52 m ²
Glazed single door W × H	149 × 185 cm	159 × 196 cm
Single window W × H	2 × 56 × 178 cm	56 × 178 cm
Fixed window W × H	—	101 × 178 cm
Floor thickness	18.5 mm	18.5 mm
Roof covering, optional	2 × 15 m	3 × 15 m
Roof shingles, optional (pack)	8	10

APPROPRIATE ACCESSORIES



Door handle



Bar unit

Other accessories can be found from page 126



Fixed glass panel

BRIGHTON ^{GOLD}

PLENTY OF SPACE, PLENTY OF LIGHT, PLENTY OF NATURE.

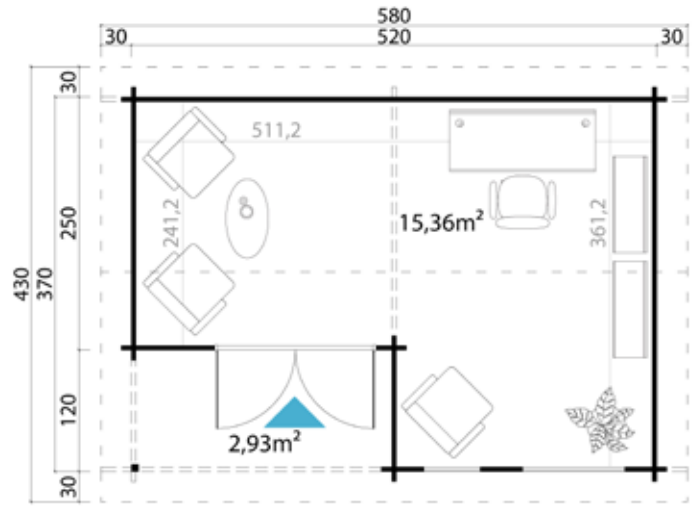

BRIGHTON 44



Hampshire

HAMPSHIRE ^{GOLD}

BRIGHT, COSY CABIN WITH SMALL, COVERED TERRACE.

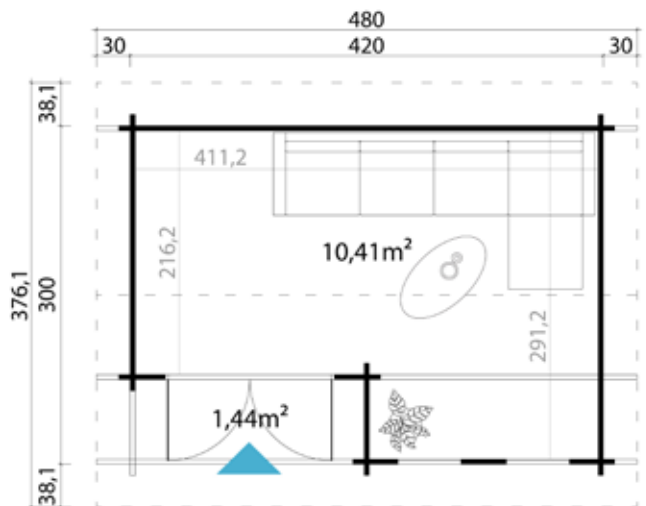

HAMPSHIRE



SNAP & WATCH



SNAP & WATCH

JAPAN GOLD

MODERN DESIGN CABIN WITH TWO FREELY POSITIONABLE INTERIOR DOORS.



JAPAN	
Item number	4424702
Base dimensions W × D	608 × 390 cm
Wall thickness	44 mm
Floor area	22.84 m ²
Capacity	54.03 m ³
Side wall height	222 cm
Ridge height	251 cm
Roof overhang	60 cm
Roof area	30.52 m ²
Glazed double door W × H	159 × 196 cm
2 × single door W × H	84 × 190 cm
2 × single window W × H	56 × 178 cm
2 × fixed window W × H	101 × 178 cm
Floor thickness	18.5 mm
Roof covering, optional	3 × 15 m
Onduline, optional	9 ×

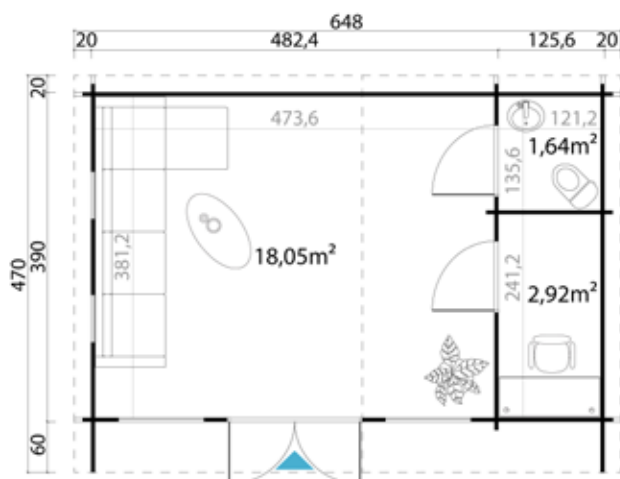



Premium window with double glazing

Reverse installation of natural cabin possible

Flexible position of the single door and window

Solid wood door

12.8 m²



SNAP & WATCH

CHAMELEON GOLD

THE TRANSFORMATIONAL WONDER WITH FLEXIBLE POSITIONING OF THE WINDOW AND SINGLE DOOR.



Alternative position of door and window



	CHAMELEON
Item number	4420002
Base dimensions W x D	450 x 300 cm
Wall thickness	44 mm
Floor area	12.85 m ²
Capacity	29.29 m ³
Side wall height	222 cm
Ridge height	234 cm
Roof overhang	80 cm
Roof area	20.93 m ²
Glazed double door W x H	159 x 196 cm
Single door W x H	84 x 195 cm
Fixed window W x H	56 x 178 cm
Floor thickness	18.5 mm
Roof covering, optional	3 x 15 m
Onduline, optional	6 x

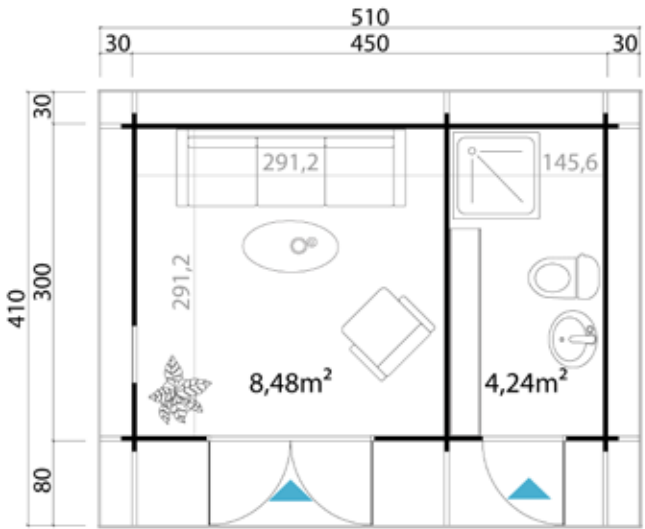

Reverse installation of natural cabin possible



	CAROLINE SILVER	CAROLINE GOLD	TERRACE
Item number	4014899.11	4014899.10	4019400
Base dimensions W × D	575 × 390 cm	575 × 390 cm	365 × 190 cm
Wall thickness	40 mm	40 mm	40 mm
Floor area	21.66 m ²	21.66 m ²	6.90 m ²
Capacity	61.11 m ³	61.11 m ³	–
Side wall height	234 cm	234 cm	–
Ridge height	331 cm	331 cm	–
Roof overhang	50 cm	50 cm	–
Roof area	37.12 m ²	37.12 m ²	–
Glazed double door W × H	149 × 196 cm	149 × 196 cm	–
Single door W × H	84 × 190 cm	84 × 190 cm	–
Double window W × H	129 × 88 cm	129 × 88 cm	–
Single window W × H	88 × 88 cm	88 × 88 cm	–
Single window W × H	54 × 54 cm	54 × 54 cm	–
Floor thickness	18.5 mm	18.5 mm	–
Roof covering, optional	4 × 15 m	4 × 15 m	–
Roof shingles, optional (pack)	14	14	–



Caroline without optional terrace

CAROLINE IS A GREAT CHOICE WITH OR WITHOUT A TERRACE.

Plenty of space – plenty of options. Caroline is perfect for a weekend in nature or as a home office in the garden. It has three rooms. The integrated additional level can be used for storage or as a sleeping loft; it is accessible via a ladder. Caroline has an additional single door which can be positioned as desired during assembly. This means that this garden cabin can be tailored exactly to your wishes.



Photos show example designs



SNAP & WATCH

CAROLINE GOLD SILVER

ENDLESS SPACE – ENJOY THE WEEKEND IN THE GARDEN WITH THE FAMILY.



CAROLINE

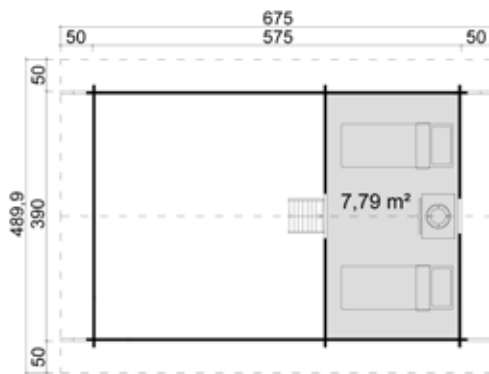

CAROLINE LOFT



TERRACE



SNAP & WATCH

CAROLINE 2.1 GOLD

LIGHT-FLOODED GARDEN CABIN WITH THREE ROOMS AND SLEEPING LOFT.



	CAROLINE 2.1	CAROLINE 2.2
Item number	4022299.10	4022299.20.1
Base dimensions W × D	575 × 390 cm	390 × 575 cm
Wall thickness	40 mm	40 mm
Floor area	21.66 m ²	21.66 m ²
Capacity	61.11 m ³	61.11 m ³
Side wall height	234 cm	234 cm
Ridge height	331 cm	331 cm
Roof overhang	50 cm	50 cm
Roof area	37.12 m ²	37.12 m ²
Double door W × H	266 × 196 cm	266 × 196 cm
Single door W × H	84 × 190 cm	84 × 190 cm
Double window W × H	129 × 88 cm	129 × 88 cm
Single window W × H	88 × 88 cm	88 × 88 cm
Single window W × H	54 × 54 cm	54 × 54 cm
Fixed window W × H	—	150 × 51 cm
Floor thickness	18.5 mm	18.5 mm
Roof covering, optional	4 × 15 m	4 × 15 m
Roof shingles, optional (pack)	14	14

APPROPRIATE ACCESSORIES



Roof shingles in various colours



Window shutters



Bar unit

Other accessories can be found from page 126



21.6 m²



SNAP & WATCH



CAROLINE 2.1



CAROLINE 2.2

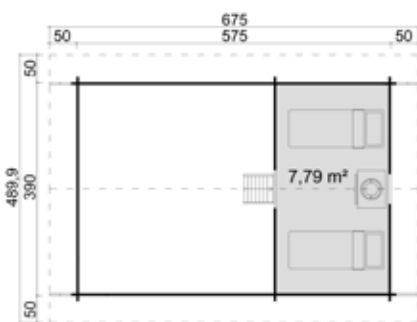

CAROLINE 2.1 LOFT

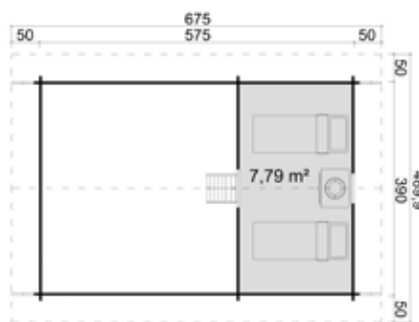

CAROLINE 2.2 LOFT

CAROLINE
2.2 GOLD
STYLISH
GARDEN CABIN
WITH SLEEPING
LOFT AND HUGE
GLASS FRONT.



21.6 m²

Premium window
with double glazing



SNAP &
WATCH

CAROLINE 2.3 GOLD

**ENJOY NATURE WITH A COMPLETELY
OPENABLE GLASS FRONT. THREE ROOMS
INVITE YOU TO LINGER AND RELAX.**



CAROLINE 2.3

Item number	4022299.20.2
Base dimensions W × D	390 × 575 cm
Wall thickness	40 mm
Floor area	21.66 m ²
Capacity	61.11 m ³
Side wall height	234 cm
Ridge height	331 cm
Roof overhang	50 cm
Roof area	37.12 m ²
Glazed bi-fold door W × H	260 × 196 cm
Single door W × H	84 × 190 cm
Double window W × H	129 × 88 cm
Single window W × H	88 × 88 cm
Single window W × H	54 × 54 cm
Fixed window W × H	150 × 51 cm
Floor thickness	18.5 mm
Roof covering, optional	4 × 15 m
Roof shingles, optional (pack)	14

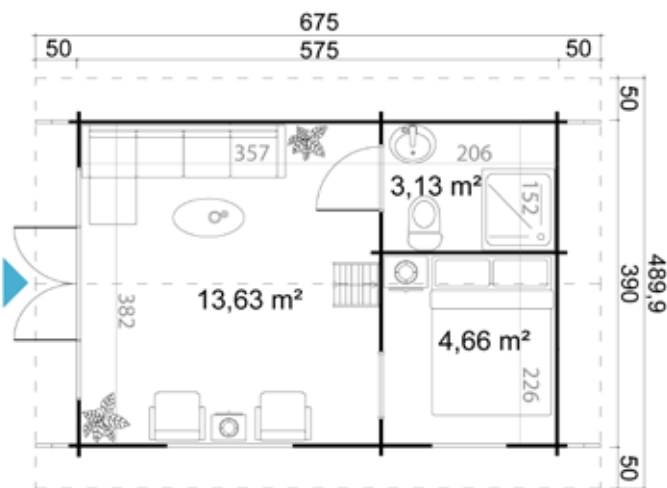

CAROLINE 2.3

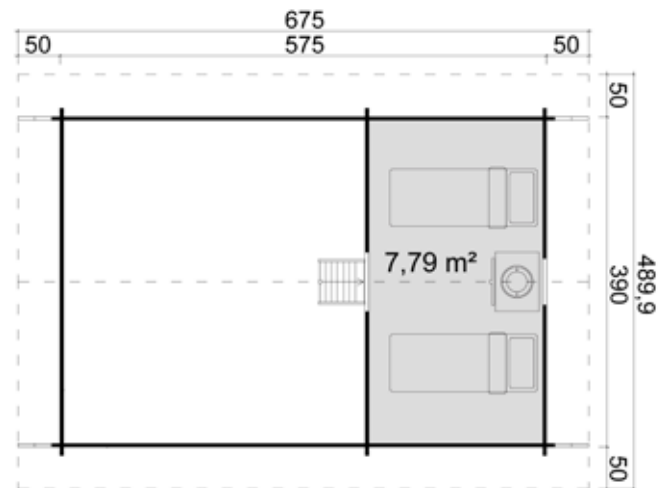

CAROLINE 2.3 LOFT

Reverse installation of natural cabin possible

Premium window with double glazing

Solid wood door



13.9 m²

Wrexham 2



SNAP & WATCH



Wrexham 1

WREXHAM GOLD

PRACTICAL GARDEN CABIN WITH SEPARATE STORE ROOM FOR GARDEN TOOLS.



	WREXHAM 1	WREXHAM 2
Item number	4416602	4416740
Base dimensions W x D	390 x 240 cm	485 x 300 cm
Wall thickness	44 mm	44 mm
Floor area	8.81 m ²	13.87 m ²
Capacity	20.35 m ³	32.01 m ³
Side wall height	211 cm	211 cm
Ridge height	251 cm	251 cm
Roof overhang	22 cm	25 cm
Roof area	13 m ²	18.90 m ²
Double door W x H	149 x 185 cm	149 x 185 cm
Single door W x H	84 x 185 cm	84 x 185 cm
Double window W x H	99 x 134 cm	99 x 134 cm
Floor thickness	18.5 mm	18.5 mm
Roof covering, optional	2 x 10 m	2 x 15 m
Roof shingles, optional (pack)	6	8

	WREXHAM 1	WREXHAM 2
Item number	4416602	4416740
Base dimensions W x D	390 x 240 cm	485 x 300 cm
Wall thickness	44 mm	44 mm
Floor area	8.81 m ²	13.87 m ²
Capacity	20.35 m ³	32.01 m ³
Side wall height	211 cm	211 cm
Ridge height	251 cm	251 cm
Roof overhang	22 cm	25 cm
Roof area	13 m ²	18.90 m ²
Double door W x H	149 x 185 cm	149 x 185 cm
Single door W x H	84 x 185 cm	84 x 185 cm
Double window W x H	99 x 134 cm	99 x 134 cm
Floor thickness	18.5 mm	18.5 mm
Roof covering, optional	2 x 10 m	2 x 15 m
Roof shingles, optional (pack)	6	8

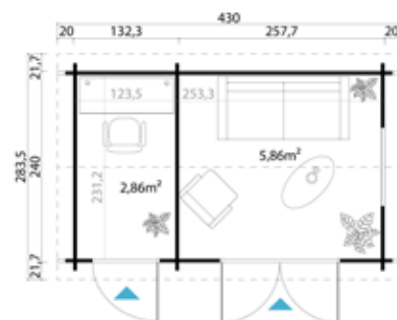

WREXHAM 1

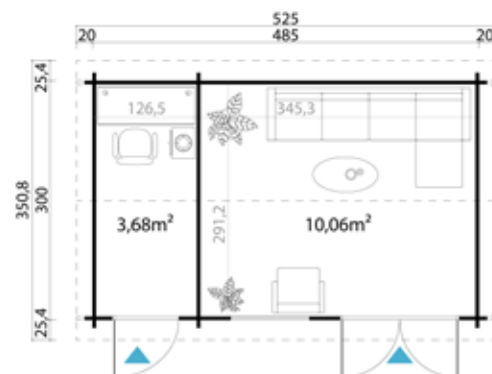

WREXHAM 2



Premium window with double glazing

Reverse installation of natural cabin possible

19.3 m²



SNAP & WATCH

BALMORAL ^{GOLD}

ASYMMETRICAL ROOF FOR THAT CERTAIN SOMETHING. WITH LARGE WINDOW FRONT.



BALMORAL 44

Item number	4417040
Base dimensions W × D	530 × 380 cm
Wall thickness	44 mm
Floor area	19.34 m ²
Capacity	42.46 m ³
Side wall height	200 cm
Ridge height	239 cm
Roof overhang	23 cm
Roof area	25.81 m ²
Double door W × H	159 × 185 cm
6 × single window W × H	71 × 122 cm
Floor thickness	18.5 mm
Roof covering, optional	3 × 15 m
Roof shingles, optional (pack)	12

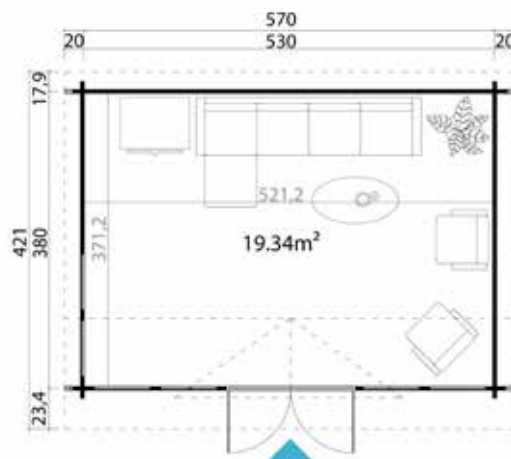

APPROPRIATE ACCESSORIES



Roof shingles in various colours



Flower box

Other accessories can be found from page 126



ALEX GOLD

CLASSIC GARDEN CABIN, PERFECT FOR SMALL GARDENS.



	ALEX	ALEX MINI
Item number	4414440	4416540
Base dimensions W × D	300 × 250 cm	250 × 200 cm
Wall thickness	44 mm	44 mm
Floor area	7.02 m ²	4.61 m ²
Capacity	16.01 m ³	10.51 m ³
Side wall height	211 cm	211 cm
Ridge height	245 cm	245 cm
Roof overhang	29 cm	27 cm
Roof area	10.88 m ²	7.83 m ²
Double door W × H	124 × 185 cm	124 × 185 cm
Double window W × H	99 × 134 cm	–
Single window W × H	–	53 × 134 cm
Floor thickness	18.5 mm	18.5 mm
Roof covering, optional	1 × 15 m	1 × 10 m
Roof shingles, optional (pack)	5	4

APPROPRIATE ACCESSORIES

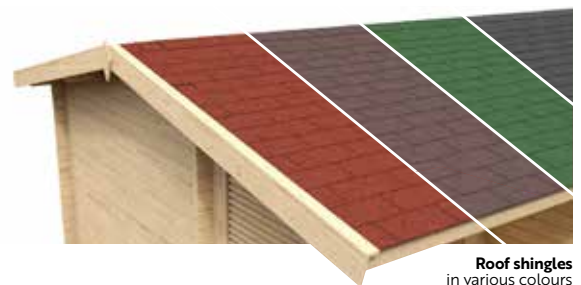

Roof shingles in various colours



Gutter

Other accessories can be found from page 126

Reverse installation of natural cabin possible



4,6 m² Alex Mini



SNAP & WATCH

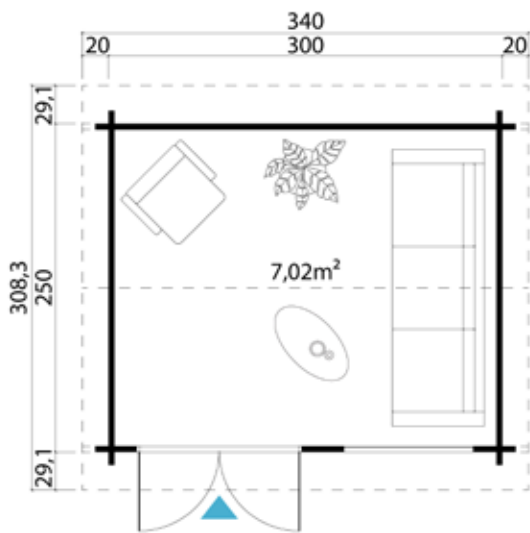

ALEX

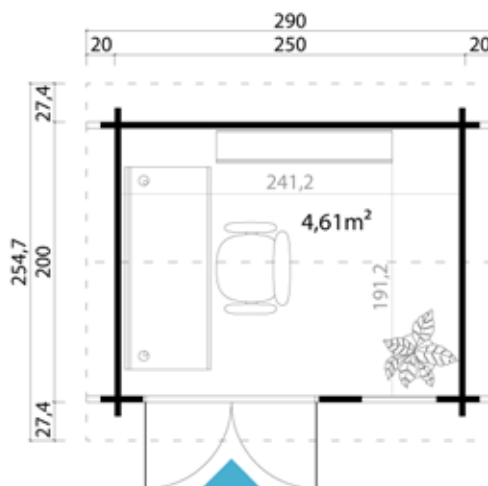

ALEX MINI

Reverse installation of natural cabin possible

Ideal as home office

Premium window with double glazing

11.1 m²



SNAP & WATCH

JUBILEE GOLD

COMPACT GARDEN CABIN WITH LARGE GLASS FRONT FOR LOTS OF NATURAL LIGHT.



	JUBILEE 44
Item number	4411202
Base dimensions W × D	350 × 300 cm
Wall thickness	44 mm
Floor area	9.94 m ²
Capacity	23.22 m ³
Side wall height	222 cm
Ridge height	245 cm
Roof overhang	60 cm
Roof area	15.54 m ²
Double door W × H	266 × 196 cm
Single window W × H	53 × 167 cm
Floor thickness	18.5 mm
Roof covering, optional	2 × 15 m
Roof shingles, optional (pack)	6

APPROPRIATE ACCESSORIES



Terrace



Premium roofing paper

Other accessories can be found from page 126



Elgin Gold: Premium window with double glazing

Select your door and window quality.



SNAP & WATCH

ELGIN GOLD SILVER

SPACIOUS, MODERN CABIN WITH FLOOR-TO-CEILING WINDOWS.



	ELGIN 44 SILVER	ELGIN 44 GOLD
Item number	4415992.11	4415992.10
Base dimensions W × D	480 × 360 cm	480 × 360 cm
Wall thickness	44 mm	44 mm
Floor area	16.55 m ²	16.55 m ²
Capacity	40.09 m ³	40.09 m ³
Side wall height	217 cm	217 cm
Ridge height	268 cm	268 cm
Roof overhang	50 cm	50 cm
Roof area	23.22 m ²	23.22 m ²
Double door W × H	159 × 196 cm	159 × 196 cm
4 × single window W × H	56 × 178 cm	56 × 178 cm
Floor thickness	18.5 mm	18.5 mm
Roof covering, optional	2 × 15 m	2 × 15 m
Roof shingles, optional (pack)	9	9

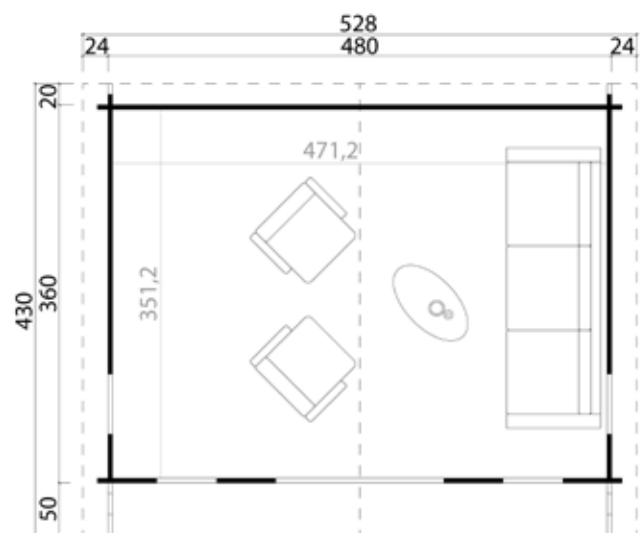

Reverse installation of natural cabin possible

Premium window with double glazing



16.2 m²



SNAP & WATCH

BARUDA GOLD

SPACIOUS AND MODERN GARDEN CABIN, IDEAL FOR THE NEXT POOL PARTY.



BARUDA

Item number	407999
Base dimensions W x D	510 x 330 cm
Wall thickness	40 mm
Floor area	16.16 m ²
Capacity	35.01 m ³
Side wall height	211 cm
Ridge height	222 cm
Roof overhang	55 cm
Roof area	23.79 m ²
Double door W x H	159 x 196 cm
3 x single window W x H	71 x 122 cm
Floor thickness	18.5 mm
Roof covering, optional	3 x 15 m
Roof shingles, optional (pack)	10
Onduline, optional	7 x

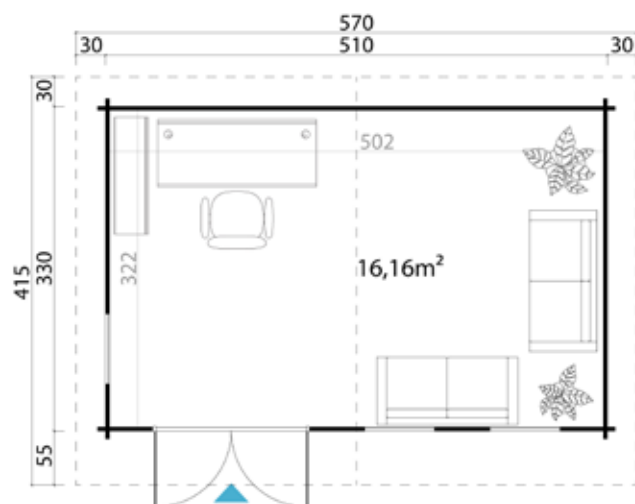

Reverse installation of natural cabin possible

Select your door and window quality.

Sri Lanka Gold: Premium window with double glazing

Sri Lanka Silver: Classic with single glazing

26 m²



SNAP & WATCH

SRI LANKA GOLD SILVER

LARGE CABIN WITH LOTS OF WINDOWS, AVAILABLE IN TWO QUALITIES.



	SRI LANKA SILVER	SRI LANKA GOLD
Item number	443892.11	443892.10
Base dimensions W × D	560 × 480 cm	560 × 480 cm
Wall thickness	44 mm	44 mm
Floor area	25.97 m ²	25.97 m ²
Capacity	65.88 m ³	65.88 m ³
Side wall height	222 cm	222 cm
Ridge height	285 cm	285 cm
Roof overhang	20 cm	20 cm
Roof area	32.40 m ²	32.40 m ²
Double door W × H	159 × 196 cm	159 × 196 cm
5 × single window W × H	71 × 122 cm	71 × 122 cm
Floor thickness	18.5 mm	18.5 mm
Roof covering, optional	3 × 15 m	3 × 15 m
Roof shingles, optional (pack)	13	13

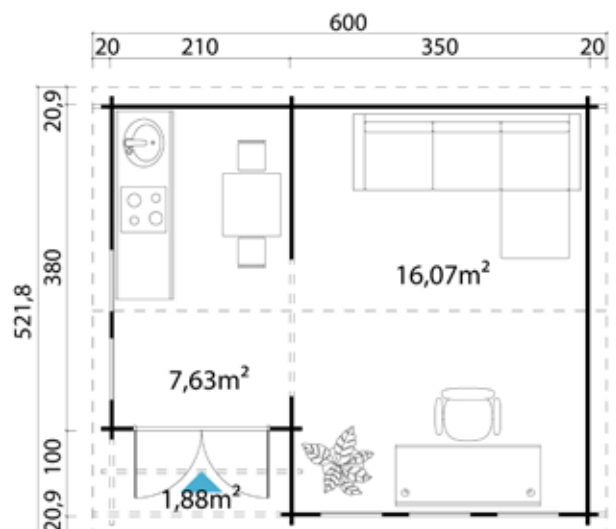

Reverse installation of natural cabin possible

Round arch on windows and door

Premium window with double glazing

11.4 m²



SNAP & WATCH

WINDSOR GOLD

A TOUCH OF VICTORIAN ELEGANCE IN YOUR OWN GARDEN.



WINDSOR 44

Item number	4415240
Base dimensions W × D	400 × 300 cm
Wall thickness	44 mm
Floor area	11.39 m ²
Capacity	25.65 m ³
Side wall height	211 cm
Ridge height	239 cm
Roof overhang	23 cm
Roof area	16.30 m ²
Double door W × H	124 × 185 cm
3 × double window W × H	99 × 134 cm
Floor thickness	18.5 mm
Roof covering, optional	2 × 10 m
Roof shingles, optional (pack)	8

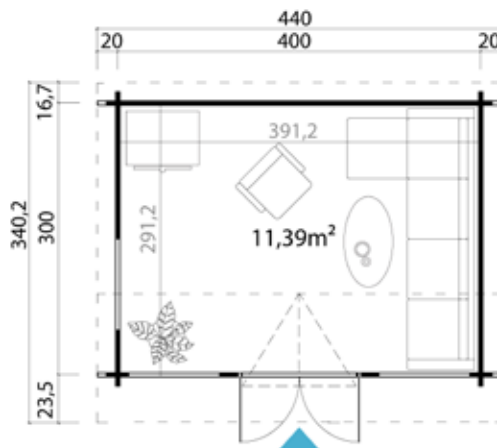

APPROPRIATE ACCESSORIES



Premium roofing paper

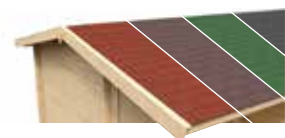

Roof shingles in various colours

Other accessories can be found from page 126



9.44 m²



SNAP & WATCH

KENSINGTON ^{GOLD}

ROMANTIC, VICTORIAN-STYLE CABIN WITH ROUND ARCHES.



	KENSINGTON
Item number	4414340
Base dimensions W × D	400 × 250 cm
Wall thickness	44 mm
Floor area	9.44 m ²
Capacity	20.71 m ³
Side wall height	200 cm
Ridge height	239 cm
Roof overhang	21 cm
Roof area	14.24 m ²
Double door W × H	124 × 185 cm
2 × double window W × H	99 × 134 cm
Floor thickness	18.5 mm
Roof covering, optional	2 × 15 m
Roof shingles, optional (pack)	7

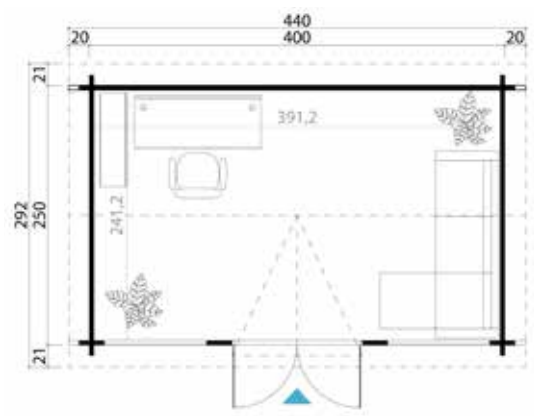

APPROPRIATE ACCESSORIES



Premium roofing paper

Other accessories can be found from page 126



SNAP & WATCH

PEMBROKESHIRE ^{GOLD}

SPACIOUS GARDEN CABIN WITH PLENTY OF SPACE FOR LEISURE ACTIVITIES.



PEMBROKESHIRE 53

Item number	4414740
Base dimensions W × D	480 × 280 cm
Wall thickness	44 mm
Floor area	12.78 m ²
Capacity	28.04 m ³
Side wall height	200 cm
Ridge height	239 cm
Roof overhang	33 cm
Roof area	19.44 m ²
Double door W × H	124 × 185 cm
2 × double window W × H	99 × 134 cm
Floor thickness	18.5 mm
Roof covering, optional	2 × 15 m
Roof shingles, optional (pack)	8

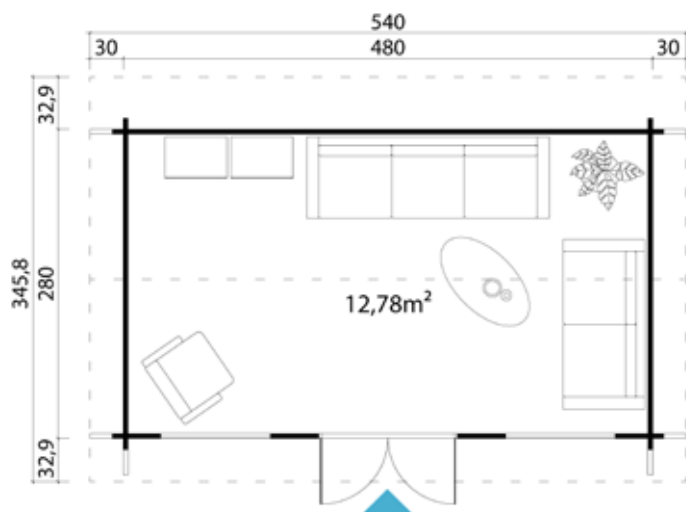

Flexible positioning of the double door and double window

Round arch on windows and door

Premium window with double glazing



11.3 m²



SNAP & WATCH

PORTSMOUTH ^{GOLD} ROMANTIC CABIN WITH THE SPECIAL LAYOUT AROUND THE CORNER.



PORTSMOUTH 44

Item number	4420102
Base dimensions W x D	400 x 400 cm
Wall thickness	44 mm
Floor area	11.29 m ²
Capacity	25.76 m ³
Side wall height	211 cm
Ridge height	245 cm
Roof overhang	25 cm
Roof area	19.40 m ²
Double door W x H	124 x 185 cm
Double window W x H	99 x 134 cm
Single window W x H	53 x 134 cm
Floor thickness	18.5 mm
Roof covering, optional	2 x 15 m
Roof shingles, optional (pack)	9

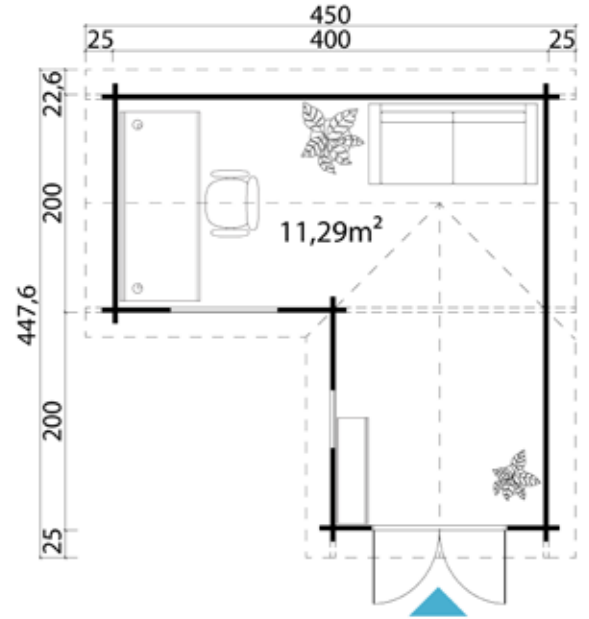

Premium window with double glazing, U-value 2.8

NOW AVAILABLE
IN 4 COLOURS!

Multi-point locking system

Bi-fold door

Including terrace

15.3 m²



SNAP & WATCH

LYNDHURST DIAMOND

**LIKE A SMALL HOLIDAY HOME
WITH A COSY VERANDA
AND PLENTY OF LIGHT INSIDE.**

**APPROPRIATE
ACCESSORIES**



	LYNDHURST	LIVERPOOL 1	LIVERPOOL 2	LIVERPOOL 3
Item number	7011902	7016344	4428244	4428319
Base dimensions W × D	550 × 300 cm	550 × 300 cm	550 × 300 cm	550 × 300 cm
Wall thickness	70 mm	70 mm	44 mm	44 mm
Floor area	15.33 m ²	15.33 m ²	15.76 m ²	15.76 m ²
Capacity	34.40 m ³	34.66 m ³	36.83 m ³	36.83 m ³
Side wall height	197 cm	221 cm	228 cm	228 cm
Ridge height	245 cm	236 cm	239 cm	239 cm
Roof overhang	130 cm	130 cm	115 cm	115 cm
Roof area	28.88 m ²	28.16 m ²	25.10 m ²	25.10 m ²
Glazed door W × H	410 × 200 cm	410 × 200 cm	410 × 200 cm	340 × 198 cm
Floor thickness	18.5 mm	18.5 mm	18.5 mm	18.5 mm
Roof covering	3 × 15 m	3 × 15 m	3 × 15 m	3 × 15 m
Roof shingles, optional (pack)	11	–	–	–
Onduline, optional	–	7 ×	6 ×	6 ×

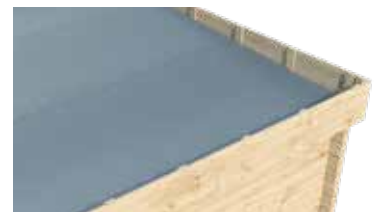

Onduline



Bar unit

Other accessories
can be found from page 126



Liverpool 3

15.8 m²



Liverpool 1

Wood bi-fold door



Liverpool 2

Wood bi-fold door

LIVERPOOL DIAMOND

A WIDE WINDOW FRONTAGE PROVIDES GREAT INTERIOR LIGHT WITH LARGE, COVERED TERRACE.

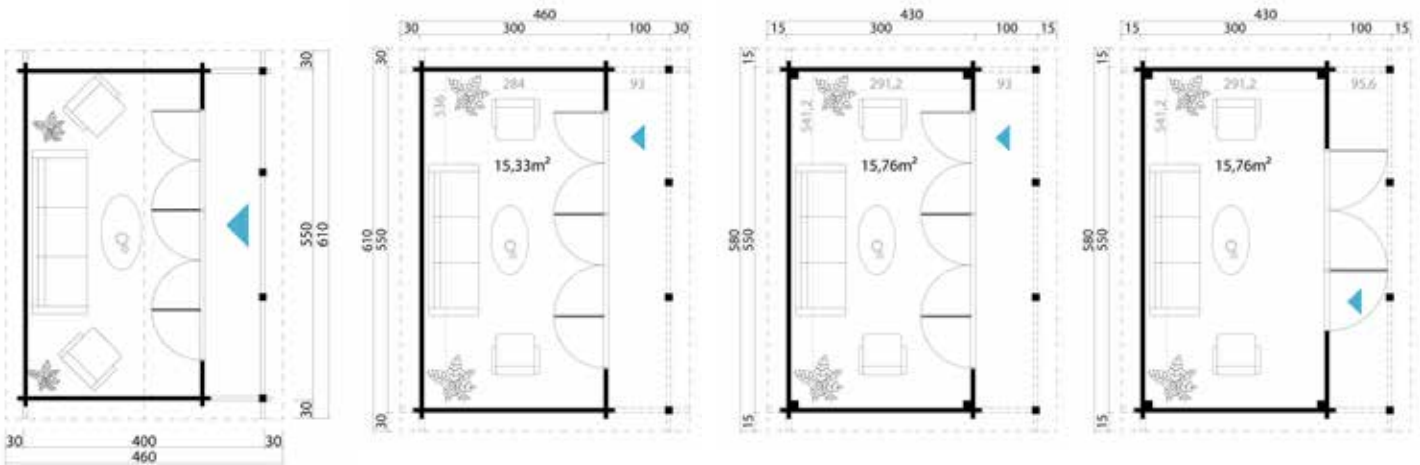

LYNDHURST

LIVERPOOL 1

LIVERPOOL 2

LIVERPOOL 3



CHILDREN'S PLAYHOUSES.

A SEPARATE KINGDOM
FOR LITTLE EXPLORERS.

07

MODELS

03

COLOURS

02

WALL
THICKNESSES





Reverse installation of natural cabin possible



Including flower box

Including terrace and floor

4.4 m²



SNAP & WATCH

LIDO BRONZE **CE**
A PLAY PARADISE FOR THE LITTLE ONES.

	LIDO
Item number	284799
Base dimensions W × D	215 × 215 cm
Wall thickness	28 mm
Floor area	4.38 m ²
Capacity	8.12 m ³
Side wall height	160 cm
Ridge height	211 cm
Roof overhang	95 cm
Roof area	9.90 m ²
Single door W × H	75 × 138.5 cm
Single window W × H	56 × 54 cm
Floor thickness	18.5 mm
Roof covering, optional	1 × 15 m
Roof shingles, optional (pack)	5

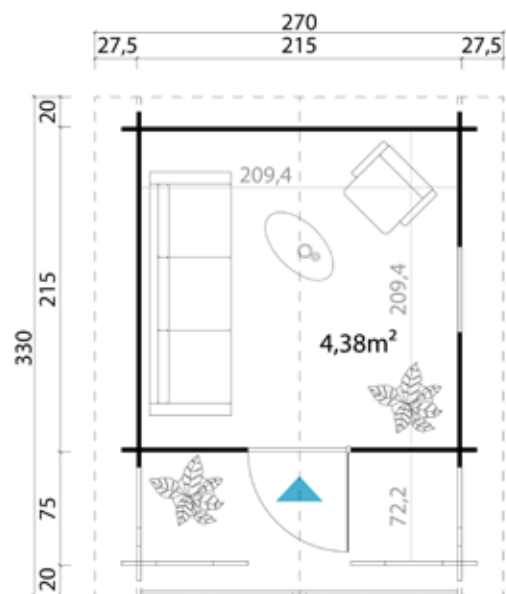

Reverse installation of natural cabin possible



Plexiglas®

Including terrace

3.1 m²

PINOCCHIO BRONZE CE

BEAUTIFUL CABIN INCLUDING COSY TERRACE.



PINOCCHIO

Item number	197000
Base dimensions W × D	180 × 180 cm
Wall thickness	19 mm
Floor area	3.10 m ²
Capacity	5.22 m ³
Side wall height	148 cm
Ridge height	188 cm
Roof overhang	80 cm
Roof area	6.48 m ²
Single door W × H	74 × 138 cm
Fixed window W × H	54 × 54 cm
Floor thickness	15.5 mm
Roof covering, optional	1 × 15 m
Roof shingles, optional (pack)	3

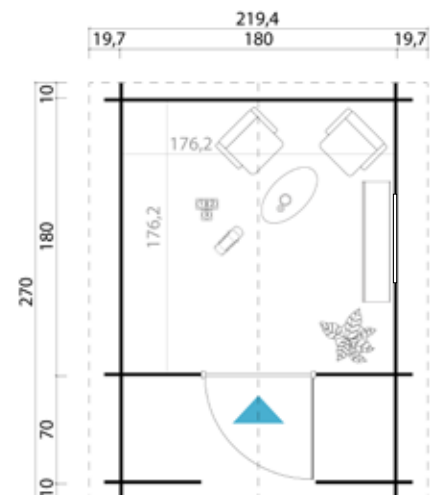



FLIPP BRONZE **CE**

ULTRAMODERN, BRIGHT CABIN WITH PRACTICAL TERRACE.



	FLIPP
Item number	199500
Base dimensions W × D	200 × 160 cm
Wall thickness	19 mm
Floor area	3.06 m ²
Capacity	5.24 m ³
Side wall height	154 cm
Ridge height	188 cm
Roof overhang	15 cm
Roof area	4.40 m ²
Single door W × H	74 × 138 cm
Fixed window W × H	56 × 122 cm
Floor thickness	15.5 mm
Roof covering, optional	1 × 15 m

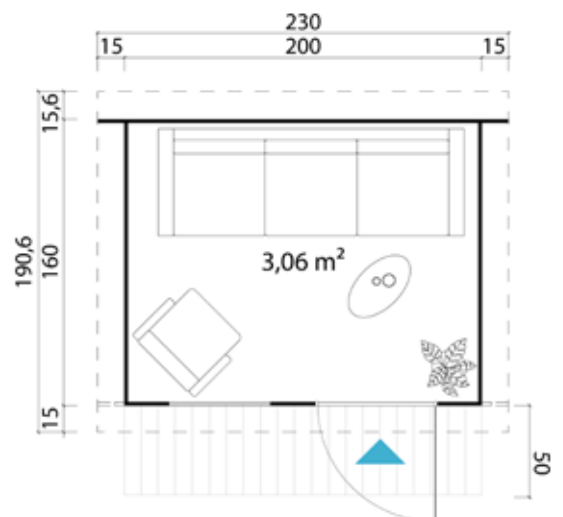



2.3 m²

PINGO BRONZE CE

A TALL REFUGE FOR SLIGHTLY OLDER CHILDREN.



	PINGO
Item number	199600
Base dimensions W × D	200 × 120 cm
Wall thickness	19 mm
Floor area	2.28 m ²
Capacity	4.03 m ³
Side wall height	165 cm
Ridge height	188 cm
Roof overhang	60 cm
Roof area	4.90 m ²
Single door W × H	74 × 138 cm
3 × single window W × H	54 × 54 cm
Floor thickness	15.5 mm
Roof covering, optional	1 × 15 m

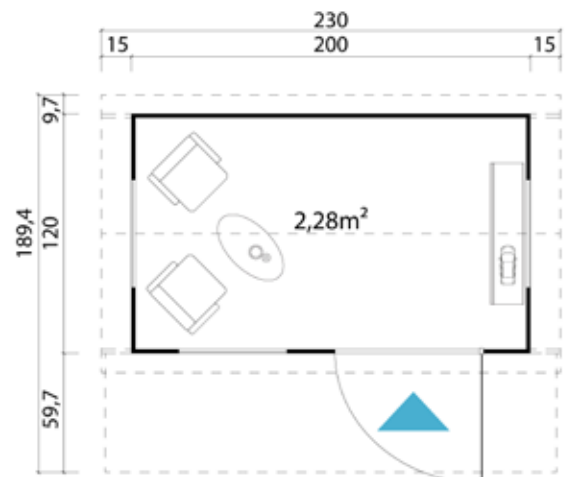



Safety
Regular
Production
Surveillance
www.tuv.com
ID: 0000085782



Tivoli 1
+ swing set



3.5 m²

Swing set includes two swings



Tivoli 1

TIVOLI BRONZE CE FOR LITTLE ADVENTURERS.



	TIVOLI 1	SWING SET
Item number	199800	9911900
Base dimensions W × D	160 × 230 cm	232 × 246 cm
Wall thickness	19 mm	-
Floor area	3.53 m ²	5.7 m ²
Capacity	6.24 m ³	-
Side wall height	160 cm	-
Ridge height	193 cm	206.5 cm
Roof overhang	20 cm	-
Roof area	5 m ²	-
Fixed window W × H	Ø 56 cm	-
Roof covering, optional	1 × 10 m	-

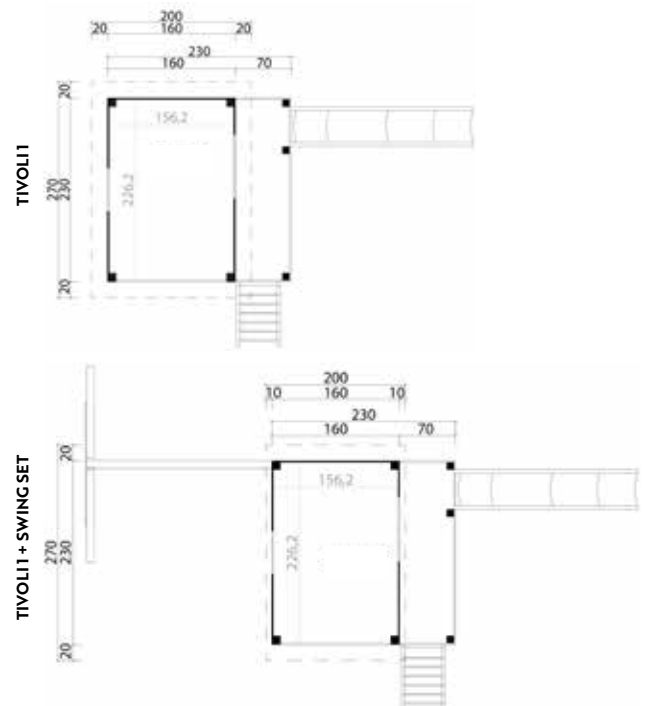



3.2 m² Pippi 1

PIPPI BRONZE CE



	PIPPI 1	PIPPI 2
Item number	9909100	9909200
Base dimensions W × D	150 × 222 cm	200 × 272 cm
Wall thickness	19 mm	19 mm
Floor area	3.19 m ²	4.08 m ²
Capacity	3.89 m ³	4.1 m ³
Side wall height	102.6 cm	102.6 cm
Ridge height	141.36 cm	141.36 cm
Roof overhang	15 cm	15 cm
Roof area	3.9 m ²	4.7 m ²
Roof covering, optional	1 × 10 m	1 × 10 m



Pippi 1 with optional cover

COVER CE



	COVER 1	COVER 2
Item number	9913000	9913100
Dimensions W × D	145 × 165 cm	195 × 215 cm
Thickness	19 mm	19 mm

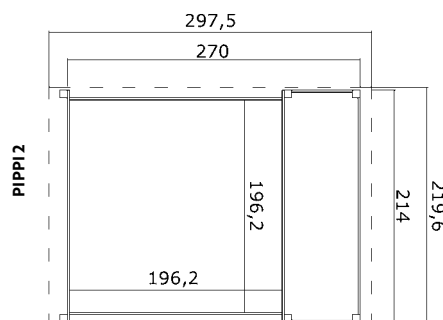
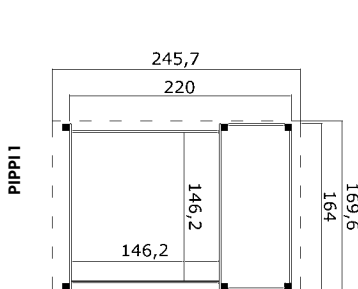



Photo shows example design for the Nevis garage

GARAGES.

THE PLACE FOR STORAGE,
WORKING OR THE WORKSHOP.

05

MODELS

04

COLOURS

01

WALL
THICKNESSES



All garages can be ordered in four variants: 1. without garage door, 2. with wood double garage door, 3. with Hörmann steel up-and-over garage door with profile board frame. 4. new to the range is our sectional garage door, which you can order for selected models.



Key facts

SPRUCE 44 MM

DOUBLE TONGUE AND GROOVE

IMPREGNATED SUBSTRUCTURE

ROOF BOARDS 15.5 / 18.5 MM

SAFETY GLASS

CONSTRUCTION	
1 Wall thickness mm	44
2 Double tongue and groove	+
Wind-tight chalet connection	+
3 Wind protection	Storm strip
4 Impregnated substructure	+
5 Floorboards	Without floor
ROOF CONSTRUCTION	
6 Roof boards	18.5 mm
7 Roof construction	Roof purlins

05

-YEAR
WARRANTY
ON THE CONSTRUCTION

GARAGES. **THE OPTIMAL SPACE,** **NOT ONLY FOR A CAR.**

Do you need more space in your home? No problem! Our garages offer ideal storage options for your vehicle, your bikes or even your workshop. All garages are delivered without a floor.



WINDOW

Wood type glued wood	Untreated spruce
1 Profile thickness mm	44
2 Mullions	(With) screws
3 Safety glass	Single (4 mm)
U-value > W / m ² K	5.6
4 Drip cap	Wood
5 Window opening	Interior
Opening system	2-hand tilt&turn



SAFETY GLASS

DOORS

Wood type glued wood	Untreated spruce
1 Profile thickness mm	44
2 Mullions	(With) screws
3 Safety glass	Single (4 mm)
U-value > W / m ² K	5.6
4 Door threshold	Aluminium
5 Door opening	Exterior
Lock	Cylinder



SAFETY GLASS

Mirror-inverted assembly possible

Premium window with double glazing

Solid wood door

35 m²



1. Bahamas without garage door, 2. Bahamas with up-and-over garage door, 3. Bahamas with wood garage door, 4. Bahamas with sectional garage door

BAHAMAS ^{GOLD}

ULTRAMODERN GARAGE WITH PLENTY OF STORAGE SPACE AND A SMART CARPORT.

	BAHAMAS WITHOUT GARAGE DOOR	BAHAMAS WITH UP-AND-OVER GARAGE DOOR	BAHAMAS WITH WOOD GARAGE DOOR	BAHAMAS WITH SECTIONAL GARAGE DOOR
Item number	4428152	4428152.13	4428152.12	4428152.14
Base dimensions W × D	660 × 540 cm	660 × 540 cm	660 × 540 cm	660 × 540 cm
Wall thickness	44 mm	44 mm	44 mm	44 mm
Floor area	34.59 m ²	34.59 m ²	34.59 m ²	34.59 m ²
Capacity	84.78 m ³	84.78 m ³	84.78 m ³	84.78 m ³
Side wall height	239 cm	239 cm	239 cm	239 cm
Ridge height	251 cm	251 cm	251 cm	251 cm
Roof overhang	10 cm	10 cm	10 cm	10 cm
Roof area	38.10 m ²	38.10 m ²	38.10 m ²	38.10 m ²
Garage door	–	240 × 205 cm	240 × 205 cm	240 × 205 cm
Single door W × H	84 × 190 cm	84 × 190 cm	84 × 190 cm	84 × 190 cm
Single window W × H	56 × 178 cm	56 × 178 cm	56 × 178 cm	56 × 178 cm
2 × fixed window W × H	150 × 41 cm	150 × 41 cm	150 × 41 cm	150 × 41 cm
Roof covering, optional	4 × 15 m	4 × 15 m	4 × 15 m	4 × 15 m
Onduline, optional	9 ×	9 ×	9 ×	9 ×

APPROPRIATE ACCESSORIES



Premium roofing paper



Onduline

Other accessories can be found from page 126



SECTIONAL GARAGE DOOR SIMPLE, QUICK AND EFFICIENT INSTALLATION.

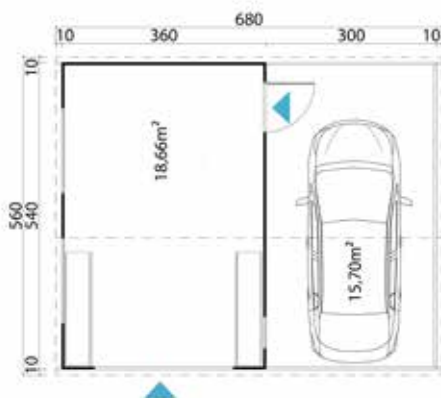

	SECTIONAL GARAGE DOOR
Item number	9906800
Garage door dimensions W × H	240 × 205.2 cm
Panel thickness	40 mm
Steel plate thickness	0.32 mm
Heat transition coefficient	1.3 W / m ² K



CONVINCING DETAILS

- Plastic handle on the inside for manual opening of the garage door
- Fast operation (150 mm/s)
- 2 remote controls
- Sandwich panel: Cold rolled DX51 + Z structural steel, hot-dip galvanised – Sendzimir system

2 additional fixed windows

NEW!



BAHAMAS 2 ^{GOLD}

PROTECTED AND LIGHT-FILLED – WHERE PRIVACY MEETS CLASSIC ELEGANCE.



	BAHAMAS WITHOUT GARAGE DOOR	BAHAMAS WITH UP-AND-OVER GARAGE DOOR	BAHAMAS WITH WOOD GARAGE DOOR	BAHAMAS WITH SECTIONAL GARAGE DOOR
Item number	4428152	4428152.13	4428152.12	4428152.14
Base dimensions W × D	660 × 540 cm	660 × 540 cm	660 × 540 cm	660 × 540 cm
Wall thickness	44 mm	44 mm	44 mm	44 mm
Floor area	34.59 m ²	34.59 m ²	34.59 m ²	34.59 m ²
Capacity	84.78 m ³	84.78 m ³	84.78 m ³	84.78 m ³
Side wall height	239 cm	239 cm	239 cm	239 cm
Ridge height	251 cm	251 cm	251 cm	251 cm
Roof overhang	10 cm	10 cm	10 cm	10 cm
Roof area	38.10 m ²	38.10 m ²	38.10 m ²	38.10 m ²
Garage door	–	240 × 205 cm	240 × 205 cm	240 × 205 cm
Single door W × H	84 × 190 cm	84 × 190 cm	84 × 190 cm	84 × 190 cm
Single window W × H	56 × 178 cm	56 × 178 cm	56 × 178 cm	56 × 178 cm
2 × fixed window W × H	150 × 41 cm	150 × 41 cm	150 × 41 cm	150 × 41 cm
Roof covering, optional	4 × 15 m	4 × 15 m	4 × 15 m	4 × 15 m
Onduline, optional	9 ×	9 ×	9 ×	9 ×

NEW!

Premium window with double glazing



18.7 m²



1. Bahamas 2 with sectional door, 2. Bahamas 2 with up-and-over door, 3. Bahamas 2 with wooden door

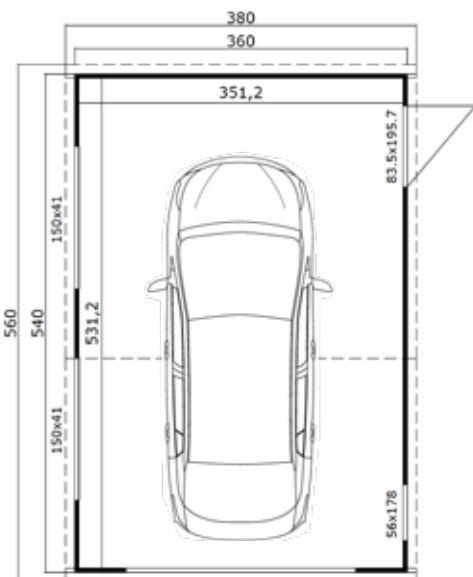

APPROPRIATE ACCESSORIES



Onduline



Premium roofing paper

Other accessories can be found from page 126



1. Canberra with up-and-over garage door 2. Canberra with wood garage door



	CANBERRA WITHOUT GARAGE DOOR	CANBERRA WITH UP-AND-OVER GARAGE DOOR	CANBERRA WITH WOOD GARAGE DOOR
Item number	4412193	4412193.13	4412193.12
Base dimensions W × D	360 × 540 cm	360 × 540 cm	360 × 540 cm
Wall thickness	44 mm	44 mm	44 mm
Floor area	18.66 m ²	18.66 m ²	18.66 m ²
Capacity	42.54 m ³	42.54 m ³	42.54 m ³
Side wall height	222 cm	222 cm	222 cm
Ridge height	234 cm	234 cm	234 cm
Roof overhang	40 cm	40 cm	40 cm
Roof area	24.90 m ²	24.90 m ²	24.90 m ²
Garage door	–	238 × 208 cm	239 × 202 cm
Single door W × H	84 × 196 cm	84 × 196 cm	84 × 196 cm
2 × fixed window W × H	150 × 41 cm	150 × 41 cm	150 × 41 cm
Floor thickness	–	–	–
Roof covering, optional	4 × 15 m	4 × 15 m	4 × 15 m
Onduline, optional	6 ×	6 ×	6 ×



SNAP & WATCH





CANBERRA SILVER
**WITH SIDE ENTRANCE DOOR IN FROSTED
GLASS FOR LIGHT AND MORE PRIVACY.**



1. Hawaii without garage door, 2. Hawaii with up-and-over garage door, 3. Hawaii with wood garage door, 4. Hawaii with sectional garage door

HAWAII SILVER

BEAUTIFUL SKYLIGHT, A SEPARATE STORE ROOM AND SPACE FOR TWO CARS.

	HAWAII WITHOUT GARAGE DOOR	HAWAII WITH UP-AND-OVER GARAGE DOOR	HAWAII WITH WOOD GARAGE DOOR	HAWAII WITH SECTIONAL GARAGE DOOR
Item number	4410693	4410693.13	4410693.12	4410693.14
Base dimensions W × D	780 × 520 cm	780 × 520 cm	780 × 520 cm	780 × 520 cm
Wall thickness	44 mm	44 mm	44 mm	44 mm
Floor area	39.42 m ²	39.42 m ²	39.42 m ²	39.42 m ²
Capacity	103.23 m ³	103.23 m ³	103.23 m ³	103.23 m ³
Side wall height	228 cm	228 cm	228 cm	228 cm
Ridge height	321 cm	321 cm	321 cm	321 cm
Roof overhang	20 cm	20 cm	20 cm	20 cm
Roof area	51.66 m ²	51.66 m ²	51.66 m ²	51.66 m ²
Garage door	–	238 × 208 cm	239 × 202 cm	240 × 205 cm
Single door W × H	84 × 185 cm	84 × 185 cm	84 × 185 cm	84 × 185 cm
3 × fixed window W × H	150 × 41 cm	150 × 41 cm	150 × 41 cm	150 × 41 cm
Floor thickness	–	–	–	–
Roof covering, optional	8 × 10 m	8 × 10 m	8 × 10 m	8 × 10 m
Roof shingles, optional (pack)	19	19	19	19

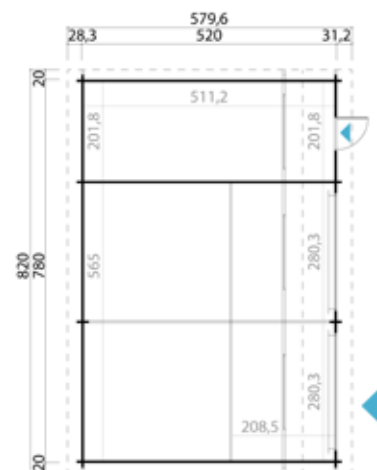

Reverse installation of natural cabin possible

Position of the door and window can be freely selected during installation

Roof installation possible in two directions

Classic window with single glazing

Solid wood garage doors



1. Falkland without garage door
2. Falkland with up-and-over garage door
3. Falkland with wood garage door



SNAP & WATCH

FALKLAND SILVER

SPACIOUS GARAGE FOR TWO CARS, WORKSHOP AND STORE ROOM.



AVAILABLE WITH STORE ROOM FLOOR IF DESIRED

	FALKLAND WITHOUT GARAGE DOOR	FALKLAND WITH UP-AND-OVER GARAGE DOOR	FALKLAND WITH WOOD GARAGE DOOR
Item number	4414193	4414193.13	4414193.12
Base dimensions W x D	575 x 575 cm	575 x 575 cm	575 x 575 cm
Wall thickness	44 mm	44 mm	44 mm
Floor area	32.06 m ²	32.06 m ²	32.06 m ²
Capacity	85.88 m ³	85.88 m ³	85.88 m ³
Side wall height	222 cm	222 cm	222 cm
Ridge height	314 cm	314 cm	314 cm
Roof overhang	30 cm	30 cm	30 cm
Roof area	41.91 m ²	41.91 m ²	41.91 m ²
Garage door	-	238 x 208 cm	239 x 202 cm
Single door W x H	84 x 196 cm	84 x 196 cm	84 x 196 cm
Double window W x H	129 x 88 cm	129 x 88 cm	129 x 88 cm
Floor thickness	-	-	-
Roof covering, optional	4 x 15 m	4 x 15 m	4 x 15 m
Roof shingles, optional (pack)	16	16	16

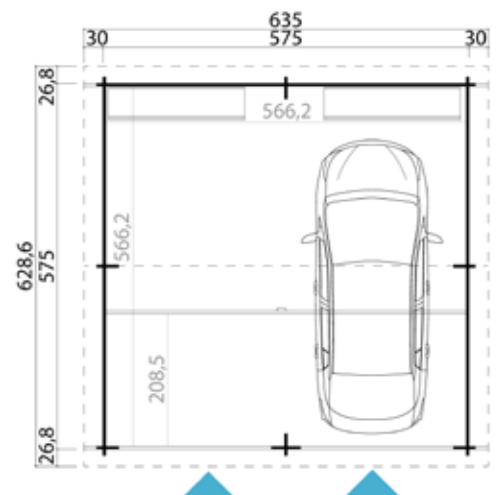

PAVILIONS

THE PLACE FOR EATING,
DRINKING, CELEBRATING
AND WELCOMING PEOPLE.

04

MODELS

04

COLOURS

01

WALL
THICKNESSES







05

**-YEAR
WARRANTY**
ON THE CONSTRUCTION



- 1** Wall thickness mm
- 2** Double tongue and groove
- 3** Wind protection
- 4** Wall insulation
- 5** Impregnated substructure
- 6** Floorboards

CONSTRUCTION

44
+
Threaded rod or storm strip
Design-dependent, optional
+
18.5 mm

- 7** Roof boards
- 8** Roof construction

ROOF CONSTRUCTION

18.5 mm
Roof purlins

Key facts

SPRUCE 44 MM

DOUBLE TONGUE AND GROOVE

IMPREGNATED SUBSTRUCTURE

FLOORBOARDS 15.5 / 18.5 MM

ROOF BOARDS 15.5 / 18.5 MM

SAFETY GLASS

**U-VALUE WINDOW /
DOOR 5.6 / 3.3**

PAVILIONS.

STURDY DESIGN, HIGH-QUALITY WORKMANSHIP AND BEAUTIFUL DETAILS.

Our pavilions feature top-notch details in high quality, including solid door fittings, sturdy door hinges, real glass doors and windows, prefabricated roof panels and cylindrical security locks. Thus, the round buildings appear airy and light with very stable and high-grade construction at the same time.



Photos show example designs

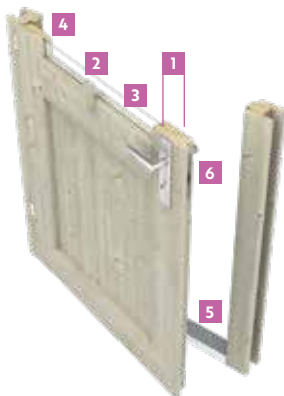
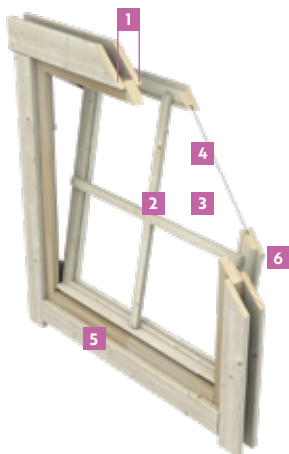

WINDOW

Wood type glued wood	Untreated spruce
1 Profile thickness mm	44
2 Mullions	(With) screws
3 Safety glass	Single (4 mm) or double (3 / 5 / 3)
U-value > W / m ² K	5.6 or 3.3
4 Rubber seal	Design-dependent
5 Drip cap	Wood / aluminium
Window opening	Inwards or inwards / outwards
6 Opening system	2-hand tilt&turn



SAFETY GLASS

DOORS

Wood type glued wood	Untreated spruce
1 Profile thickness mm	44
2 Mullions	(With) screws
3 Safety glass	Single (4 mm) or double (3 / 5 / 3)
U-value > W / m ² K	5.6 or 3.3
4 Rubber seal	Design-dependent
5 Door threshold	Aluminium / coated metal
Door opening	Exterior
6 Lock	Cylinder



SAFETY GLASS



7.5 m²



SNAP & WATCH

ILMENAU SILVER

THIS PAVILION FEATURES AN IMPRESSIVE ALL-ROUND VIEW.



	ILMENAU
Item number	442300
Base dimensions W × D	350 × 303 cm
Wall thickness	44 mm
Floor area	7.50 m ²
Capacity	18.21 m ³
Side wall height	211 cm
Ridge height	307 cm
Roof overhang	30 cm
Roof area	13.61 m ²
Double door W × H	123 × 185 cm
2 × double window W × H	123 × 121 cm
3 × fixed window W × H	123 × 121 cm
Floor thickness	18.5 mm
Roof covering, optional	2 × 15 m
Roof shingles, optional (pack)	8

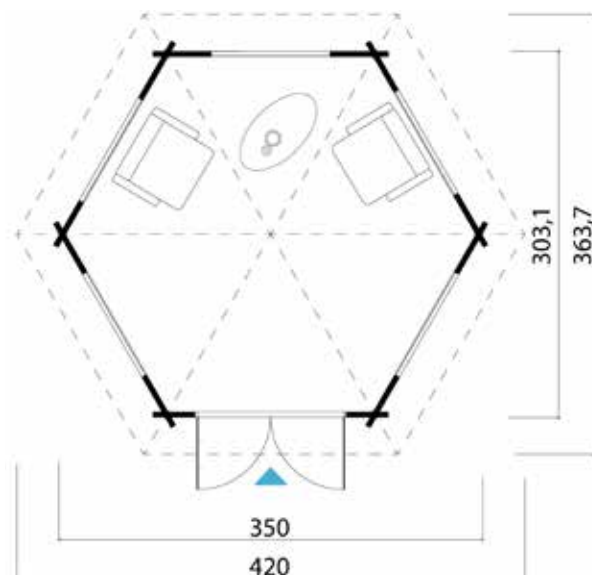



4.7 m²

INVERNESS GOLD

THE COSY RELAXATION SPOT FOR SMALL GARDENS.



INVERNESS 44

Item number	4416002
Base dimensions W × D	280 × 242 cm
Wall thickness	44 mm
Floor area	4.73 m ²
Capacity	11.21 m ³
Side wall height	211 cm
Ridge height	290 cm
Roof overhang	17 cm
Roof area	7.78 m ²
Single door W × H	84 × 185 cm
2 × single window W × H	71 × 167 cm
Floor thickness	18.5 mm
Roof covering, optional	1 × 15 m
Roof shingles, optional (pack)	4

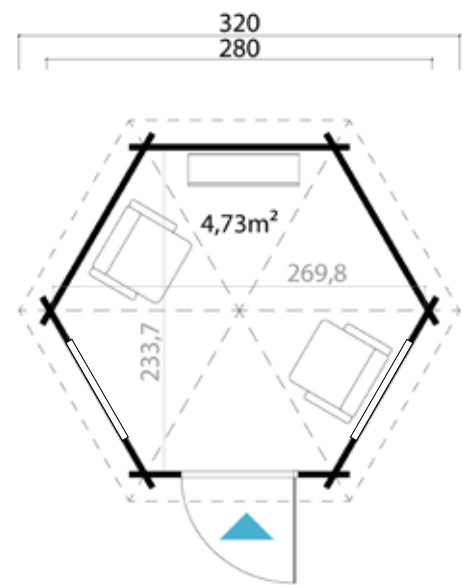



SNAP & WATCH

RIVERA GOLD

PERFECT FOR COSY HOURS OUTDOORS.



	RIVERA 44
Item number	4416802
Base dimensions W × D	350 × 303 cm
Wall thickness	44 mm
Floor area	7.50 m ²
Capacity	20 m ³
Side wall height	228 cm
Ridge height	318 cm
Roof overhang	30 cm
Roof area	13.23 m ²
Double door W × H	124 × 196 cm
2 × double window W × H	99 × 134 cm
Floor thickness	18.5 mm
Roof covering, optional	2 × 15 m
Roof shingles, optional (pack)	8

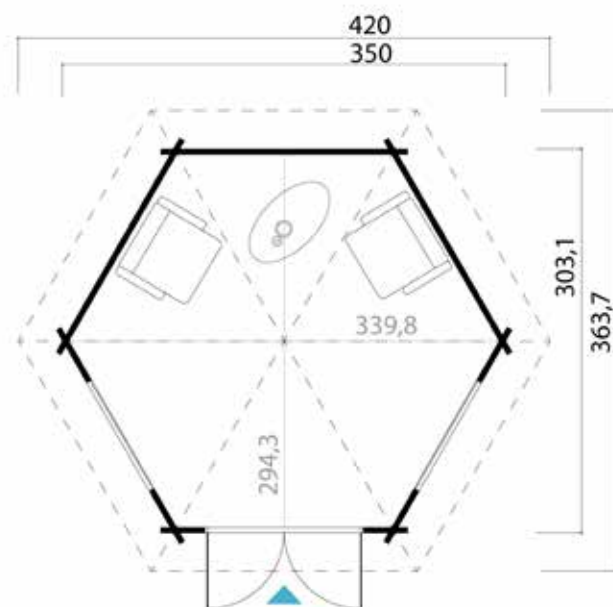



SNAP & WATCH

JAMAICA SILVER

LIGHT-FLOODED PAVILION FOR COFFEE WITH FRIENDS IN THE GARDEN.



	JAMAICA
Item number	442400
Base dimensions W x D	347 x 347 cm
Wall thickness	44 mm
Floor area	9.46 m ²
Capacity	24.04 m ³
Side wall height	217 cm
Ridge height	345 cm
Roof overhang	21 cm
Roof area	15.15 m ²
Double door W x H	100 x 185 cm
3 x double window W x H	100 x 121 cm
4 x fixed window W x H	100 x 121 cm
Floor thickness	18.5 mm
Roof covering, optional	2 x 15 m
Roof shingles, optional (pack)	9

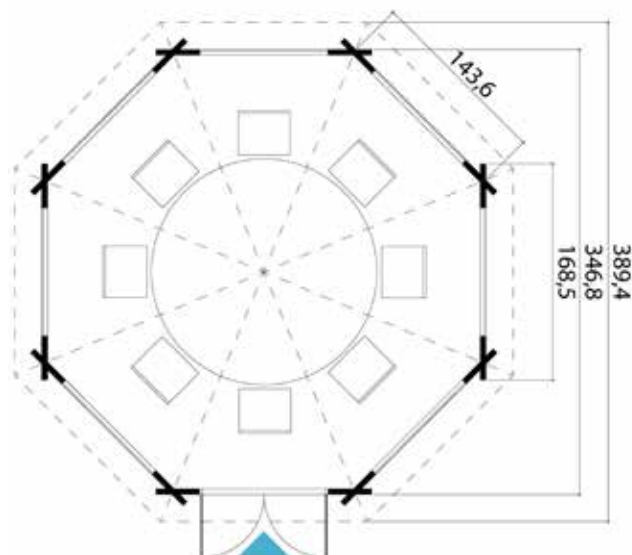

A man with a beard, wearing a blue long-sleeved shirt and light-colored shorts, is holding a young child with blonde hair. They are standing on a wooden deck in front of a wooden building with large glass doors. The man is looking at the child and smiling. The background shows a green landscape under a clear sky.

90

MODELS

02

WALL
THICKNESSES

HOLIDAY HOMES

**FAMILY. RELAXING. GETTING OUT.
TAKING THINGS EASY. ALL IN ONE PLACE.**





These soon become cosy little homes for living in during the year's brief time-outs. Find your own personal time-out house with us!

1



2



3

A diverse selection

From small to huge: **1** Mont Blanc, the L-shaped cabin with a floor area of 50 m², will win you over with large terrace windows for relaxing in natural light.

2 A terrace can also be added to each of our holiday homes.

3 The Malmö cabin offers plenty of space over two floors, as well as an optional roof over the terrace. Windows on three sides allow sun to flood in at any time of day

4 The Mälaren cabin will also win you over with its high quality and plenty of room in a small space.



4

WHETHER ONE OR TWO STOREYS, 40 OR 100 SQUARE METRES – YOUR PERFECT FEEL-GOOD RETREAT AWAITS!

//

*NOT BEING A STRANGER
AWAY FROM HOME. NOT
HAVING TO WONDER IF
ALL THE UTENSILS WILL BE
THERE. WHAT THE BED
LINEN IS LIKE. THAT IS
WHAT A HOLIDAY MEANS
TO ME.*

**SIMPLY HOP IN THE
CAR AND ARRIVE.
AT HOME, YET AWAY.**



ARE YOU LOOKING FOR A VERY SPECIAL HOLIDAY HOME?

WITH US YOU CAN PLAN AND CREATE YOUR OWN HOLIDAY HOME ABSOLUTELY AS YOU WISH.

Looking for something out of the ordinary? None of our products quite what you want? No problem: We plan and create individual holiday homes entirely according to your specifications, wishes and needs. We coordinate with you on all aspects of your holiday home, from design to construction. This will give you the perfect holiday home, whether for a small plot of land or a sloping site. Your individual holiday home will be produced at our Lasita Maja factory. Talk to us!



SNAP & CONTACT

Contact us for further information.

REQUEST A CATALOGUE NOW.

Your own holiday home is so close! Request your catalogue now featuring all the holiday homes from Lasita Maja. Over 100 pages of holiday feeling. And if the right house is not in the catalogue: with us you can also create your personal dream holiday home!

Simply request the catalogue from your specialist dealer or directly from us at www.lasita.com.

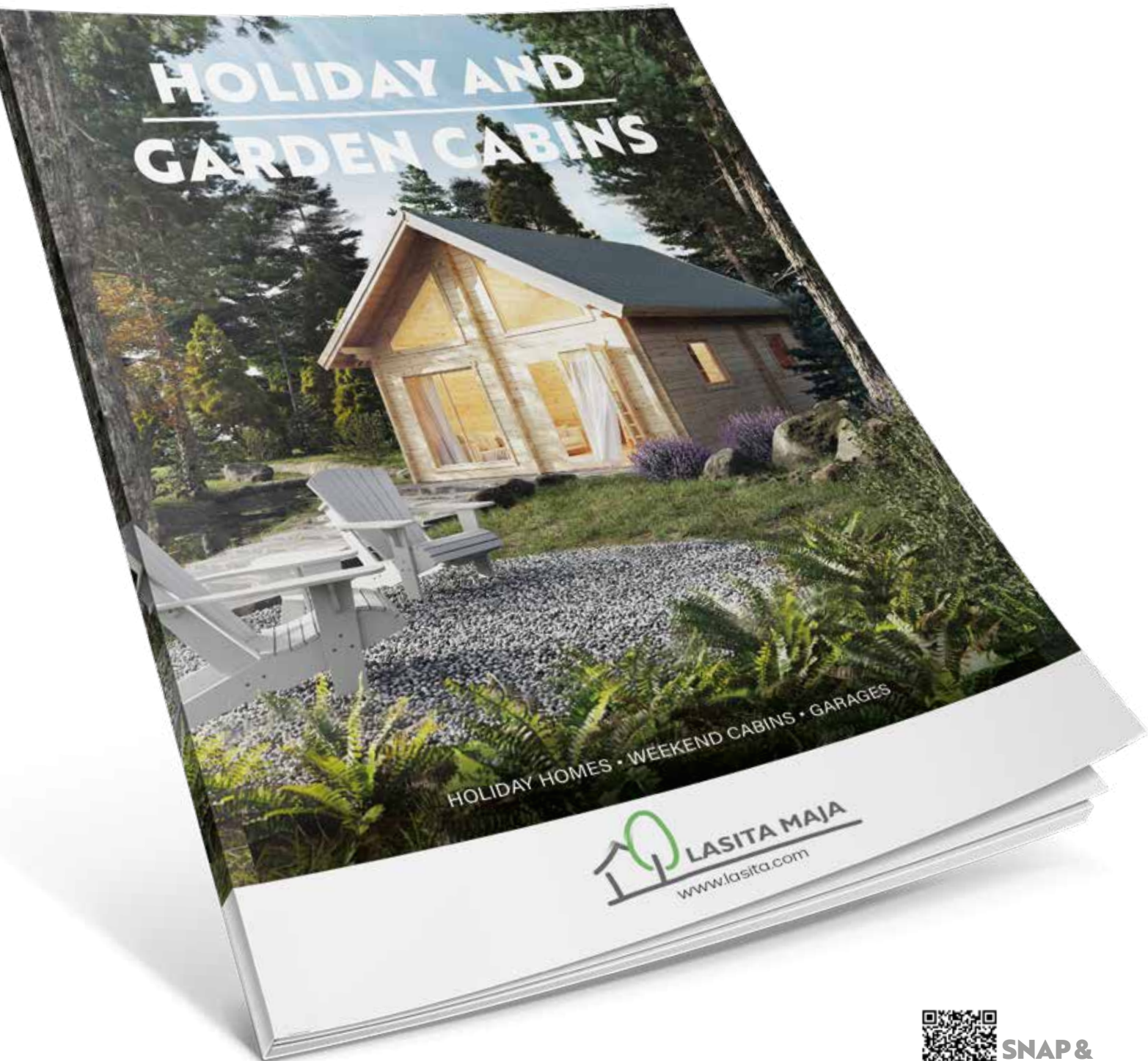

**SNAP &
WATCH**



ACCESSORIES.

FOR LOG CABINS.
INDIVIDUALLY ADAPTED TO
YOUR WANTS AND NEEDS.

25

OPTIONS



DOORS

STANDARD SINGLE DOOR



	STANDARD SINGLE DOOR
Size	835 × 1957 mm
Wood type	Spruce
Item number	UK.2.056.TSVP. MM SGC
Suitable wall thickness	28 / 34 / 40 / 44 mm
Glued wood	+
Mullions	+
Glazing	Single
Glass thickness	4 mm
U-value	5.6 W/m ² K
Silicone seal	-
Water drip	-
Opens	Exterior

MODERN SINGLE DOOR



	MODERN SINGLE DOOR
Size	835 × 1957 mm
Wood type	Spruce
Item number	UK.3.030. TMVP.MM MGC
Suitable wall thickness	28 / 34 / 40 / 44 mm
Glued wood	+
Mullions	-
Glazing	Single (frosted glass)
Glass thickness	4 mm
U-value	5.6 W/m ² K
Silicone seal	-
Water drip	-
Opens	Exterior

SOLID WOOD SINGLE DOOR



	SOLID WOOD SINGLE DOOR
Size	835 × 1975 mm
Wood type	Spruce
Item number	UL.2.100.IVP. MMW TP+
Suitable wall thickness	34 / 40 / 44 mm
Glued wood	+
Mullions	-
Glazing	-
Glass thickness	-
U-value	-
Silicone seal	-
Water drip	-
Opens	Exterior

ALL-GLASS SINGLE DOOR



	ALL-GLASS SINGLE DOOR
Size	835 × 1957 mm
Wood type	Spruce
Item number	UK.1.100.TPVP. MM DGP+
Suitable wall thickness	34 / 40 / 44 mm
Glued wood	+
Mullions	-
Glazing	Double (ISO)
Glass thickness	3 / 6 / 3 mm
U-value	3.3 W/m ² K
Silicone seal	+
Water drip	-
Opens	Exterior

STANDARD DOUBLE DOOR



ALL-GLASS DOUBLE DOOR



MODERN DOUBLE DOOR



	STANDARD DOUBLE DOOR	ALL-GLASS DOUBLE DOOR	MODERN DOUBLE DOOR
Size	1588 × 1850 mm	1494 × 1957 mm	1588 × 1975 mm
Wood type	Spruce	Spruce	Spruce
Item number	TUK.2.056.TPVP. MMW DGP+	TUK.1.108.TSVP. MMb SGC	TUK.4.020.SVP. MM SGC
Suitable wall thickness	34 / 40 / 44 mm	28 / 34 / 40 / 44 mm	28 / 34 / 40 / 44 mm
Glued wood	+	+	+
Mullions	+	+	-
Glazing	Double (ISO)	Single	Single
Glass thickness	3 / 6 / 3 mm	4 mm	4 mm
U-value	3.3 W/m ² K	5.6 W/m ² K	5.6 W/m ² K
Silicone seal	+	-	-
Water drip	-	-	-
Opens	Exterior	Exterior	Exterior

Would you like to order an extra door? No problem! Customise your garden cabin with one of our additional doors. The doors can be ordered in the appropriate thickness and with DIN left or DIN right hinges to ensure that they fit your garden cabin perfectly.

Please do not hesitate to ask your specialist dealer about options and delivery times.

WINDOW

SINGLE WINDOW 1



SINGLE WINDOW 2



SINGLE WINDOW 3



DOUBLE WINDOW



	SINGLE WINDOW 1	SINGLE WINDOW 2	SINGLE WINDOW 3	DOUBLE WINDOW
Size	685 × 882 mm	882 × 882 mm	710 × 1224 mm	1290 × 882 mm
Wood type	Spruce	Spruce	Spruce	Spruce
Item number	AK.1.106.TSSV.d SGC	AK.1.109.TPSP.b DGP+	AK.1.106.TSSP SGC	TAK.1.106.TSSP.a SGC
Suitable wall thickness	28 / 34 / 40 / 44 mm	34 / 40 / 44 mm	28 / 34 / 40 / 44 mm	28 / 34 / 40 / 44 mm
Glued wood	+	+	+	+
Mullions	+	+	+	+
Glazing	Single	Double (ISO)	Single	Single
Glass thickness	4 mm	3 / 6 / 3 mm	4 mm	4 mm
U-value	5.6 W/m ² K	3.3 W/m ² K	5.6 W/m ² K	5.6 W/m ² K
Silicone seal	-	+	-	-
Water drip	Wood	Aluminium	Wood	Wood
Opens	Interior	Interior	Interior	Interior
Opening system	2-hand tilt&turn	2-hand tilt&turn	2-hand tilt&turn	2-hand tilt&turn

MODERN SINGLE WINDOW



FLOOR-TO-CEILING SINGLE WINDOW



FLOOR-TO-CEILING DOUBLE WINDOW



SKYLIGHT (FIXED)



	MODERN SINGLE WINDOW	FLOOR-TO-CEILING SINGLE WINDOW	FLOOR-TO-CEILING DOUBLE WINDOW	SKYLIGHT (FIXED)	SKYLIGHT (FIXED) – SGC
Size	525 × 1560 mm	560 × 1780 mm	1010 × 1780 mm	1500 × 410 mm	1500 × 410 mm
Wood type	Spruce	Spruce	Spruce	Spruce	Spruce
Item number	AK.1.100.TPSP.j DGP+	AK.1.100.TPSP DGP+	TAK.1.100.TPM0.e DGP+	AK.1.100.TPM0.k DGP	AK.1.100.SM0.k SGC
Suitable wall thickness	34 / 40 / 44 mm	34 / 40 / 44 mm	34 / 40 / 44 mm	34 / 40 / 44 mm	28 / 34 / 40 / 44 mm
Glued wood	+	+	+	–	–
Mullions	–	–	–	–	–
Glazing	Double (ISO)	Double (ISO)	Double (ISO)	Double (ISO)	Single
Glass thickness	3 / 6 / 3 mm	3 / 6 / 3 mm	3 / 6 / 3 mm	3 / 6 / 3 mm	4 mm
U-value	3.3 W/m ² K	3.3 W/m ² K	3.3 W/m ² K	3.3 W/m ² K	5.6 W/m ² K
Silicone seal	+	+	+	+	–
Water drip	Aluminium	Aluminium	Aluminium	Wood	–
Opens	Interior	Interior	–	–	–
Opening system	2-hand tilt&turn	2-hand tilt&turn	2-hand tilt&turn	–	–

ACCESSORIES

STANDARD ROOFING FELT

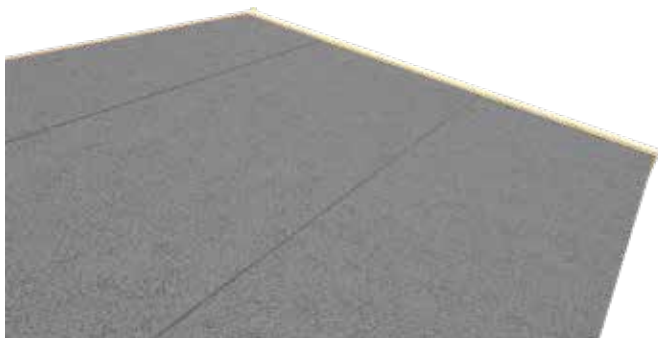

Suitable for short-term use or as underlay for other roof coverings such as shingles or premium roofing felt, available in classic Grey, on a 10 m² or 15 m² roll, dimensions 1 × 10 m

	ROLL 10	ROLL 15
Item number	261	262
Roof area	10 m ²	15 m ²

PREMIUM ROOFING FELT



High-quality polymer bitumen roofing felt – suitable for long-term, waterproof covering of roofs, available in 4 colours, on 15 m² roll, dimensions 1 × 15 m



	BLACK	RED	GREEN	BROWN
Item number	37449	37451	37452	37453
Roof area	15 m ²	15 m ²	15 m ²	15 m ²

ONDULINE



ONDULINE KSK-M is a cold self-adhesive roofing membrane with an aluminium top layer and a particularly high adhesive strength. It is easy, safe and quick to apply. The aluminium top layer offers outstanding protection against UV radiation and other environmental influences. The substrate must be dry, stable, frost-free, grease-free and resistant to abrasion. Does not stick to silicone. Unevenness, holes and similar must be levelled or filled. Dimensions 500 × 100 cm

	GREY
Item number	37470
Roof area	5 m ²

ROOF SHINGLES

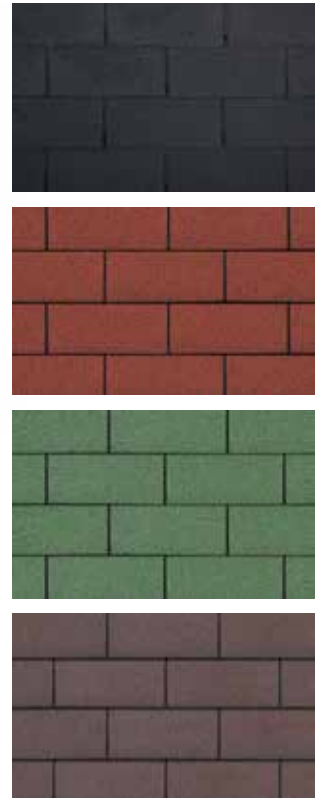

Three-strip roof shingles are the most widely used roof shingles. They are easy to install, guarantee a stylish, high-quality appearance and are available in the four most popular colours at 3 m² per pack.

	BLACK	RED	GREEN	BROWN
Item number	263	16274	16275	264
Roof area	3 m ²	3 m ²	3 m ²	3 m ²

PENT ROOF



	A 90 × 240	A 90 × 300	B 90 × 240	B 90 × 300
Item number	280700	285200	9901600	9901700
Wall thickness	–	–	19 mm	19 mm
Base dimensions W × D	90 × 240 cm	90 × 300 cm	90 × 240 cm	90 × 300 cm
Floor area	2 m ²	2.50 m ²	2 m ²	2.50 m ²
Capacity	3.50 m ³	4.40 m ³	3.50 m ³	4.40 m ³
Side wall height	166 cm	166 cm	166 cm	166 cm
Ridge height	186 cm	186 cm	186 cm	186 cm
Roof area	2.60 m ²	3.30 m ²	2.60 m ²	3.30 m ²
Roof covering, optional	1 × 15 m	1 × 15 m	1 × 15 m	1 × 15 m
Roof shingles, optional (pack)	2	2	2	2

ACCESSORIES

TERRACES

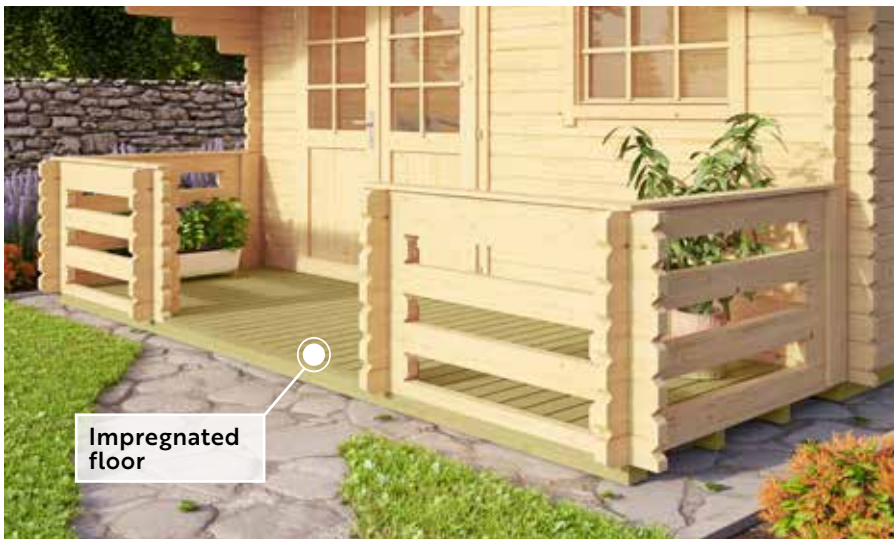

	40 3913	40 48513
Item number	4018700	4018800
Wall thickness	40 mm	40 mm
Base dimensions W × D	390 × 120 cm	485 × 120 cm
Floor area	4.20 m ²	5.30 m ²
Floor	Included	Included

FLOWER BOX



	FOR SINGLE WINDOWS
Item number	990600
Box width	84.6 cm

	FOR DOUBLE WINDOWS
Item number	990800
Box width	125.4 cm

BAR



	BAR UNIT
Item number	991900
Dimensions W × D	190 × 65 cm
Height	102 cm

PAINT FOR REPAINTING

If you have bought a garden cabin that has already been painted by Lasita Maja, you can obtain the original paint for repainting from a well-stocked specialist shop.



GUTTERS



Gutter sets for garden cabins with a roof depth of up to 490 cm. Consisting of gutter, gutter connector, end pieces, rainwater downpipe, pipe elbow and downpipe bracket, diameter 10 cm.

	SET A	SET A INCL. DOWNPIPE	SET B	SET B INCL. DOWNPIPE	SET C INCL. DOWNPIPE	SET D INCL. DOWNPIPE	SET E INCL. DOWNPIPE	SET F INCL. DOWNPIPE
Item number	35807	35808	35809	35810	35811	35812	35813	35814
For roof length	180 – 219 cm	180 – 219 cm	220 – 259 cm	220 – 259 cm	260 – 300 cm	301 – 349 cm	350 – 390 cm	400 – 490 cm

WINDOW SHUTTERS



Window shutters for windows (cm)	540 × 540	685 × 882	770 × 770	770 × 990
Item number	994300	994400	994500	994600
Window shutters for windows (cm)	882 × 882	882 × 990	882 × 1110	1290 × 882
Item number	994700	994800	994900	995000



All about the garden cabin

GOOD TO KNOW.



What should I consider before ordering a garden cabin?

The assembly of a garden cabin is usually regulated by local authority regulations. Prior to ordering, enquire about the applicable regulations from your local authority. We will be happy to provide you with the relevant technical data sheets and also have static calculations available for many models. If you need such documents, just ask us.

How will my garden cabin be delivered?

In principle, we deliver our garden cabins and kits to the respective ordering partner. On request, it is also possible to deliver the kit “free to the kerb” to your home. Please

note that the road access must be suitable for a 40 t HGV and your availability by telephone for the delivery agreement must be guaranteed. Unloading is carried out using a truck-mounted forklift. A sufficiently solid surface must be available for this.



Does my cabin need a foundation?

We recommend assembly on a firm foundation to which the garden cabin can also be attached. Ideally you should create a foundation slab. This should be slightly smaller (1-2 mm/side) than the substructure. It is important that the foundation is constructed in such a way that it will not give way due to rain, frost or snow, nor will it lift or sink.

What tools will I need for the assembly?

For correct assembly, you will need, among other things: Phillips and possibly Torx screwdriver, cordless screwdriver, wood drill, power drill, universal pliers, Stanley knife, saw, inch rule, spirit level, string, hammer, pencil, possibly glue, possibly clamps and a ladder. Whenever using tools, ladders etc., ensure safe handling and a secure footing. All the required screws and fittings are included in the kit. Assembly should be carried out by more than one person.



What must I consider before assembling my garden cabin?

Our garden cabins come with **two** sets of assembly instructions: the general instructions and the specific instructions that list the details of your purchased garden cabin. Read the assembly instructions carefully and check the kit against the parts list for completeness, damage and integrity. Please note: Garden cabins and holiday homes made from wood are natural products. Hairline cracks, gumming, knots and minor warping of the wood do not constitute grounds for complaint, as these are product-specific characteristics that do not affect the use of the product. Our log assembly kits (exception: system and panel cabins) should not be screwed tightly into the walls or at the door. The boards remain “loosely” connected and must have the opportunity for flexible movement (lifting and lowering).



How can I complain about damaged parts?

Complaints are accepted if they are made in writing within 14 days of delivery of the cabin. To do this, mark the relevant parts on the parts list and send this with the purchase receipt and assembly instructions (incl. control no.) to your dealer. They will process your complaint with us. A digital photo or presentation of the parts that you are not happy with serves as proof.

How do I ensure lasting protection of the garden cabin?

Our components are delivered in their natural state. Therefore, once assembled, you must paint the cabin, windows and doors on the interior and exterior with at least a colourless wood preservative. It is recommended that you use environmentally friendly water-based products for this and reapply the protective coating at least every two years. This will ensure that you can enjoy looking at and using your garden cabin for many years to come.

What form does the roofing of a garden cabin take?

If roof covering is included in the scope of delivery, we supply bitumen roofing felt for the initial covering. This should be renewed after approx. one year in order to maintain long-term rain protection. We also offer bitumen roof shingles in a high-quality and resilient form which protect the roof for a longer period of time. For our flat-roof models, we recommend our Onduline KSK-M roofing membrane as well as our gutter sets (see Accessories).

LASITA MAJA – Paint system

CARE INSTRUCTIONS.

For lasting enjoyment of your colour-stained log cabin, it is necessary to maintain the surface professionally on a regular basis. If you carry out this maintenance yourself, please read the general safety instructions in our assembly instructions and also the corresponding maintenance information. Should the surface incur minor damage during assembly or delivery, please use the paint supplied to repair this damage. This replacement paint is intended to repair small areas of mechanical damage or wood caps (spot repair) and not to paint large areas. Should you need paint for repainting, please contact your specialist dealer; they will be happy to help you.

It is important to clean the surface regularly. This will significantly extend the life of your product. Inspect your garden cabin every year for possible dirt, algae growth, damage, delamination or paint degradation. It is also important to keep the paint surface free of vegetation or plants. They prevent adequate ventilation and lead to moisture build-up. Pay particular attention to the sides facing the sun. These are exposed to more UV radiation and may need more attention.



MAINTENANCE / REPAINTING:

1. Clean the surfaces to be maintained with an appropriate cleaning agent.
2. Remove loose or porous layers of paint, preferably with a suitable abrasive material.
3. Apply the maintenance coat with a suitable brush. Ensure the paint is applied thickly and evenly.
4. Allow the paint to dry well (at least 48 h).
5. Apply a second coat to the renewed surface (attention, little paint absorption!), thereby protecting the surface.

If you carry out this maintenance correctly, you will enjoy your garden cabin for many years.

If you have any questions, please do not hesitate to contact us or your specialist dealer.

Quality features

EVERY DETAIL COUNTS.



Impregnated terrace boards

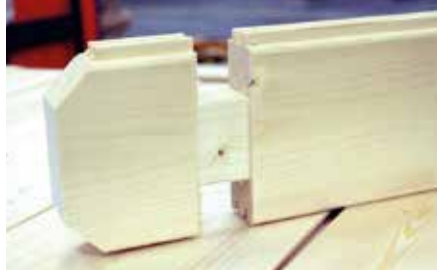

Wind-tight chalet corner connection



All end profiles included in delivery



Impregnated substructure protects the wood against moisture and extends the service life



15/18.5 mm floorboards (optionally available in 28 mm for holiday homes).



Wooden storm strips or threaded rods (depending on model) protect your garden cabin against strong winds



High-quality windows and doors



Real glass windows and doors, single glass or double glazing



1 or 2-hand tilt&turn windows (depending on model), Exception: Horizontal, fixed windows



Lockable doors, except for children's playhouses



Doors mainly with easy access



18.5 mm roof boards



Assembly instructions and accessories included



The cabins are packed very carefully for transport. UV-resistant film as well as sturdy pallets protect the garden cabins from moisture and transport damage.



**WOULD YOU LIKE
TO DISCOVER
MORE PRODUCTS?**

**WE OFFER EVERYTHING YOUR
HEART DESIRES FOR YOUR
GARDEN OR WELLNESS OASIS.**

At Lasita Maja, we are proud to be part of a strong group that achieves great things together! The close co-operation with our partner WEKA Holzbau is a real benefit for us. We combine innovative ideas, top quality and a passion for wood for the benefit of our customers and our joint success. Two companies, one mission: Growing together, strong together!
WEKA not only offers a wide range of products and services, but also first-class quality, which we are also pleased to offer you.



**SNAP &
WATCH**

For further information see
www.weka-holzbau.com

DISCOVER WEKA CATALOGUES!

Discover everything that makes your garden oasis or your home even more beautiful! Whether you are interested in an elegant solid wood pool or a soothing heat cabin - WEKA offers the ideal solution for your individual needs.

The new 'Garden & Leisure' and 'Wellness & Relaxation' catalogues invite you to immerse yourself in inspiring WEKA worlds. Whether stylish garden sheds, TABALUGA children's play equipment, spacious pools or comfortable saunas - here you will find everything your heart desires. Be inspired and redesign your time-out from everyday life!

Simply request catalogues from specialist retailers or directly from us at info@weka-holzbau.com.

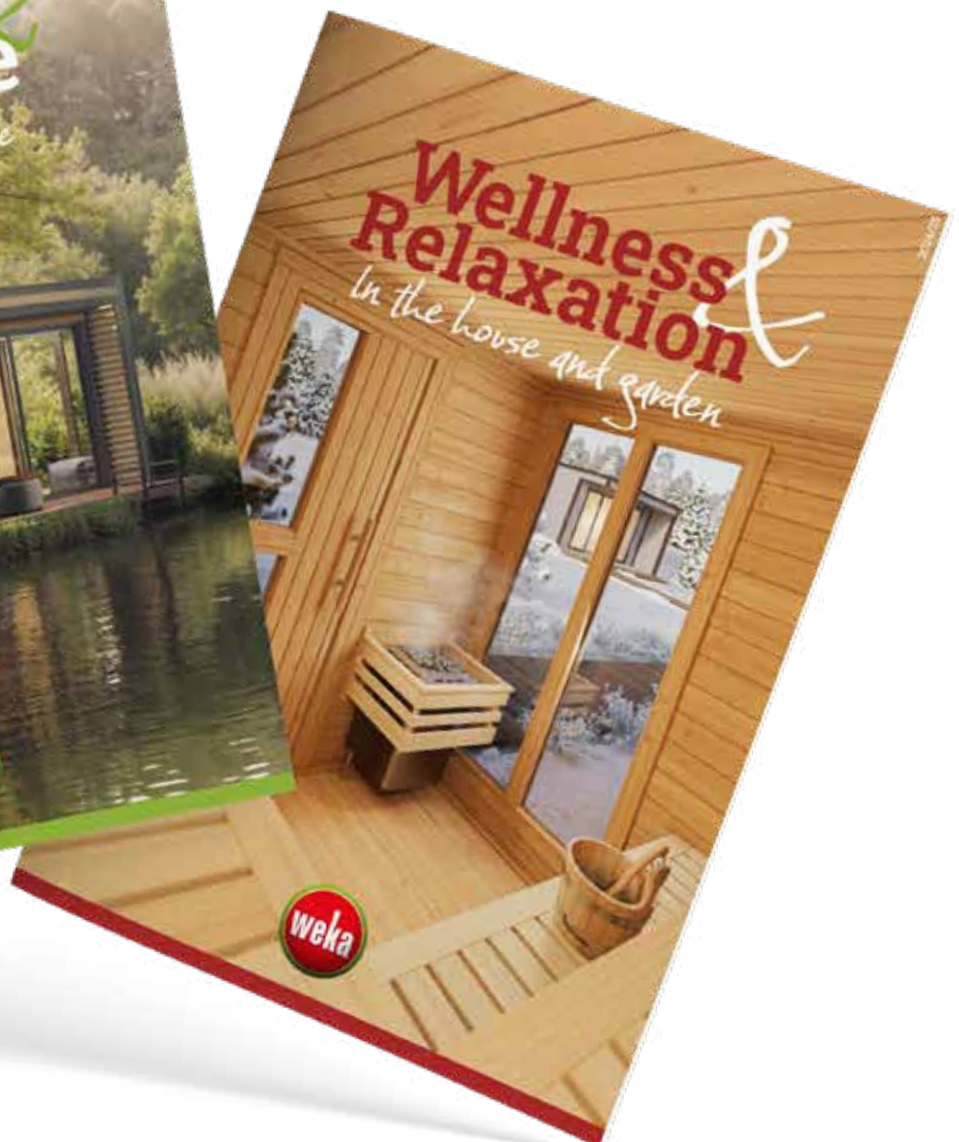



© LASITA MAJA 2025
VERSION 02/2025 EN

The dimensions specified in the catalogue are approximate. The actual dimensions may differ slightly. Unless specified to the contrary, the products are given without accessories and without decoration. We reserve the right to make technical changes to the benefit of our products, along with small design modifications. We are not liable for any printing errors. Item no. 50374